

**FM 23-15**

**WAR DEPARTMENT**

**BASIC FIELD MANUAL**

**BROWNING AUTOMATIC  
RIFLE, CALIBER .30, M1918A2  
WITH BIPOD**

**FM 23-15**

**BASIC FIELD MANUAL**

**BROWNING AUTOMATIC RIFLE  
CALIBER .30, M1918A2  
WITH BIPOD**

---

**Prepared under the direction of the  
Chief of Infantry**



**UNITED STATES  
GOVERNMENT PRINTING OFFICE  
WASHINGTON: 1940**

---

**For sale by the Superintendent of Documents, Washington, D. C., Price 25 cents**

WAR DEPARTMENT,  
WASHINGTON, August 27, 1940.

FM 23-15, Browning Automatic Rifle, Caliber .30, M1918A2, with Bipod, is published for the information and guidance of all concerned.

[A. G. 062.11 (5-28-40).]

BY ORDER OF THE SECRETARY OF WAR:

G. C. MARSHALL,  
*Chief of Staff.*

OFFICIAL:

E. S. ADAMS,  
*Major General,*  
*The Adjutant General.*

## TABLE OF CONTENTS

	Paragraphs	Page
<b>CHAPTER 1. MECHANICAL TRAINING.</b>		
Section I. General .....	1-3	1
II. Disassembly and assembly.....	4-12	3
III. Care and cleaning.....	13-15	19
IV. Functioning.....	16-23	22
V. Operation .....	24-32	36
VI. Immediate action and stoppages..	33-36	39
VII. Spare parts and accessories.....	37-38	46
VIII. Ammunition .....	39-46	49
<b>CHAPTER 2. MARKSMANSHIP, KNOWN DISTANCE TARGETS.</b>		
Section I. General .....	47-49	53
II. Preparatory marksmanship training.....	50-72	54
III. Courses to be fired.....	73-75	81
IV. Range practice .....	76-85	88
V. Regulations governing record practice.....	86-116	96
VI. Targets and ranges.....	117-118	107
<b>CHAPTER 3. MARKSMANSHIP, MOVING GROUND TARGETS.</b>		
Section I. General .....	119-120	112
II. Moving vehicles and personnel..	121-123	113
III. Moving targets, ranges, and range precautions.....	124-125	114
<b>CHAPTER 4. MARKSMANSHIP, AIR TARGETS.</b>		
Section I. General .....	126	118
II. Technique of antiaircraft fire .....	127-131	118
III. Marksmanship training.....	132-136	120
IV. Miniature range practice.....	137-140	128
V. Towed target firing.....	141-145	131
VI. Ranges, targets, and equipment..	146-151	134
<b>CHAPTER 5. TECHNIQUE OF FIRE.</b>		
Section I. General .....	152-154	145
II. Range estimation.....	155-159	146
III. Target designation.....	160-166	149
IV. Automatic rifle fire and its effect..	167-174	157
V. Application of fire.....	175-182	160
VI. Landscape target firing.....	183-190	164
VII. Field target firing.....	191-196	170
<b>CHAPTER 6. ADVICE TO INSTRUCTORS.</b>		
Section I. General .....	197	175
II. Mechanical training.....	198-199	175
III. Marksmanship, known distance targets.....	200-213	176
IV. Marksmanship, air targets.....	214-218	189
V. Technique of fire.....	219-226	195
<b>INDEX .....</b>		<b>201</b>

## BASIC FIELD MANUAL

### BROWNING AUTOMATIC RIFLE, CALIBER .30, M1918A2, WITH BIPOD

#### CHAPTER 1

#### MECHANICAL TRAINING

	Paragraphs
SECTION I. General.....	1-3
II. Disassembly and assembly.....	4-12
III. Care and cleaning.....	13-15
IV. Functioning.....	16-23
V. Operation.....	24-32
VI. Immediate action and stoppages.....	33-36
VII. Spare parts and accessories.....	37-38
VIII. Ammunition.....	39-46

#### SECTION I

#### GENERAL

■ 1. OBJECT.—This chapter is designed to give the soldier training that will insure his ability to maintain the rifle and keep it in operation.

■ 2. DESCRIPTION OF THE RIFLE.—The Browning automatic rifle, caliber .30, M1918A2, with bipod, is an air-cooled, gas-operated, magazine-fed shoulder weapon. (See fig. 1.) It weighs approximately 21 pounds without sling. The ammunition is loaded in magazines of 20 rounds. The weight of the magazine when empty is 7 ounces; when filled, 1 pound 7 ounces.

■ 3. FIRE POWER.—The Browning automatic rifle, caliber .30, M1918A2, is not capable of semiautomatic fire. There are two cyclic rates of full automatic fire, normal and slow, which may be selected by the firer. The normal cyclic rate is approximately 550 rounds per minute; the slow cyclic rate is approximately 350 rounds per minute. The effective rate of fire for this weapon is from 120 to 150 rounds per minute.

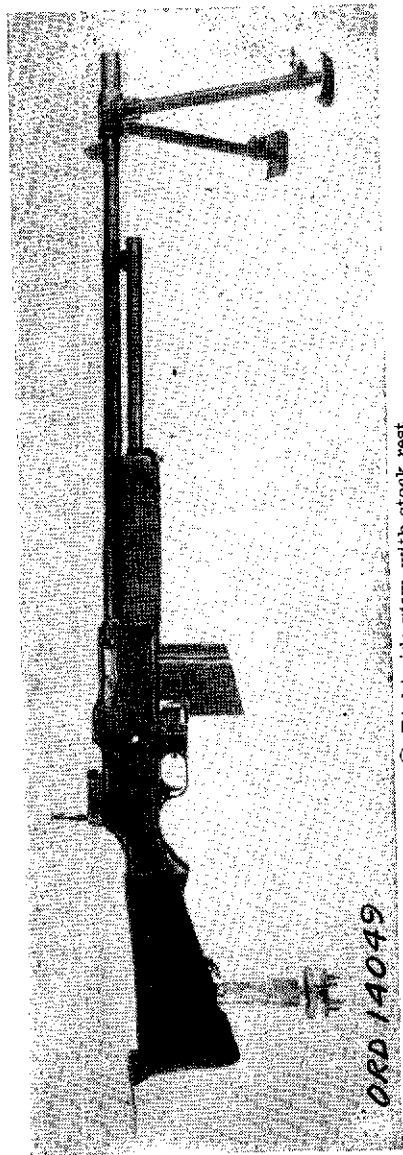

① Right side view, with stock rest.

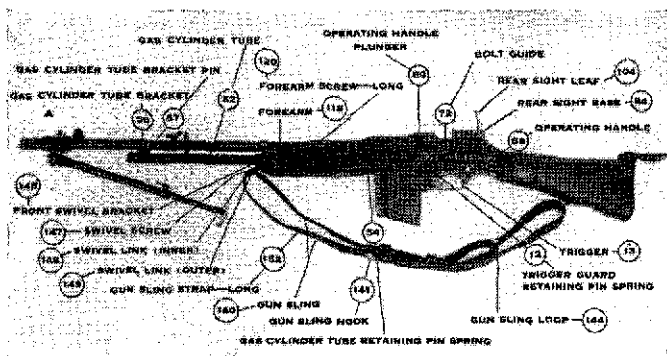

(2) Left side view.

FIGURE 1.—Browning automatic rifle, caliber .30, M1918A2, with bipod.

## SECTION II

### DISASSEMBLY AND ASSEMBLY

■ 4. TRAINING.—Training in disassembly and assembly will be taken up as soon as practicable after the soldier receives his rifle. In any case it will be completed before any firing is done with the rifle by the individual. Instruction in the care and cleaning of the automatic rifle will also be covered.

■ 5. ORGANIZATION.—In the company or platoon, all enlisted men are combined in one or more groups under their officers or selected noncommissioned officers as instructors. Other noncommissioned officers supervise the work as directed. Squad leaders supervise the work of their squads.

■ 6. CARE TO BE EXERCISED.—*a.* The rifle can be readily disassembled and assembled without applying force. The use of force is prohibited.

*b.* The rifle will not be disassembled or assembled against time as this serves no useful purpose and results in burring and damaging the parts. Instruction, blindfolded, may be given to men who have passed their tests in mechanical training. In all work in disassembling the rifle, the men

will be taught to lay the parts out on a smooth, clean surface in the proper sequence for assembling. The trigger mechanism will not be disassembled or assembled blind-folded.

■ 7. NOMENCLATURE.—The names of the parts to which reference is made in mechanical training are readily learned as this training progresses. Instructors will therefore take care to name the parts clearly and correctly in their work. A sufficient knowledge of the nomenclature of the rifle is gained by the soldier during the instruction in mechanical training.

■ 8. DISASSEMBLING THE RIFLE.—*a. General.*—Authorized disassembly by the soldier is limited to that required for proper care and maintenance of the rifle. Further disassembly will be done under the supervision of an officer or ordnance personnel. The individual soldier is prohibited from disassembling the—

- (1) Forearm group.
- (2) Barrel group.
- (3) Butt stock and buffer group.
- (4) Rear sight group.
- (5) Receiver group.

*b. Sequence.*—The disassembly of the rifle authorized to be performed by the individual soldier without supervision is performed in the following sequence:

- (1) *Operating group.*—
  - (a) Remove flash hider.
  - (b) Remove bipod assembly.
  - (c) Remove flash hider spring lock washer.
  - (d) Cock the rifle.
  - (e) Remove gas cylinder tube retaining pin.
  - (f) Remove gas cylinder tube and forearm (let mechanism forward easily).
  - (g) Remove trigger guard retaining pin.
  - (h) Remove trigger guard.
  - (i) Remove recoil spring guide and recoil spring.
  - (j) Push hammer pin through hammer pin hole in receiver.
  - (k) Remove operating handle.
  - (l) Remove hammer pin.



- (m) Remove hammer.
- (n) Remove slide.
- (o) Push out bolt guide.
- (p) Remove bolt, bolt lock, and bolt link.
- (q) Remove firing pin.
- (r) Remove bolt link pin and bolt link.
- (s) Remove extractor and spring.
- (2) *Trigger mechanism.*—Remove—
  - (a) Ejector.
  - (b) Magazine catch spring.
  - (c) Magazine catch pin.
  - (d) Magazine catch.
  - (e) Magazine release.
  - (f) Sear spring.
  - (g) Trigger pin.
  - (h) Trigger and connector.
  - (i) Sear pin.
  - (j) Sear and sear release stop lever.
  - (k) Sear carrier and counterrecoil spring.
  - (l) Change lever spring.
  - (m) Change lever.
- (3) *Bipod assembly.*—Remove the—
  - (a) Two bipod leg clamp wing screws.
  - (b) Right and left bipod leg assemblies.
  - (c) Two bipod clamp leg guides.
  - (d) Two bipod body wing screws.
  - (e) Right and left bipod leg tubes.

c. *Method.*—The following detailed explanation of the method of disassembling the automatic rifle is furnished as an aid to instructors:

(1) *Operating group.*—Unscrew flash hider. Remove bipod assembly and flash hider spring lock washer. Lay rifle on table, barrel down, pointing to left. Cock the rifle. This must be done in order that the gas cylinder tube may clear the gas piston and gas cylinder tube bracket, female. Turn gas cylinder tube retaining pin spring (54) 180° in a clockwise direction and lift out gas cylinder tube retaining pin (53). Remove gas cylinder tube and forearm (118). Let slide (45) forward *easily* by pressing trigger with thumb of right hand and at the same time grasping slide with left

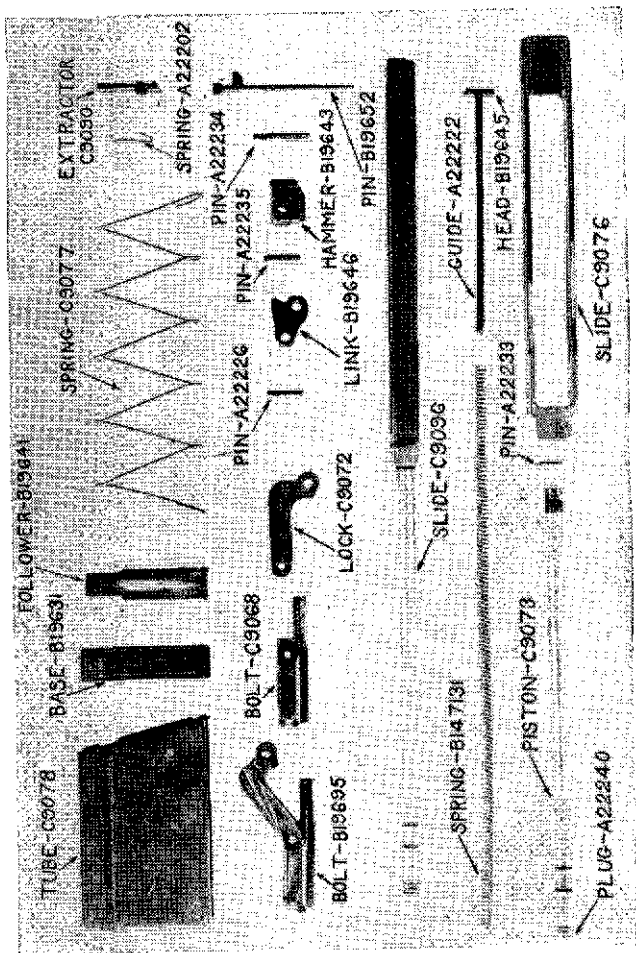

FIGURE 2.—Operating group.

hand so that middle and index fingers are astride gas piston. Turn trigger guard retaining pin spring (12) 90° in a clockwise direction and lift out pin. Lift out trigger guard group. Remove recoil spring guide (41) by pressing right index finger on checkered surface of its head and turning it until ends are clear of retaining shoulders. Line up hammer pin holes on receiver and operating handle by inserting point of recoil spring guide or dummy cartridge in hole on operating handle with right hand, press against hammer pin (86), and push operating handle backward with left hand. The recoil spring guide will push hammer pin through its hole in receiver as hammer pin registers with latter. Remove operating handle (88) by pulling straight to rear. Remove hammer pin. Push hammer (85) forward out of its seat in slide (45) and lift out of receiver. Remove slide (45) by pulling it forward out of receiver, being careful that bolt link (82) is pushed well down, thus allowing slide to clear. In removing slide, take care to avoid striking gas piston or rings against gas cylinder tube bracket (56). Force bolt guide (72) out with left thumb or point of a bullet. Lift out bolt, bolt lock, and bolt link by pulling them slowly to rear end of receiver and up with right thumb and forefinger. Pull out firing pin (76) from its way in bolt (75). Push bolt link pin (83) and remove bolt link. Remove extractor (77) by pressing point of a dummy cartridge against claw and exerting pressure upward and to front. Remove extractor spring.

(2) *Trigger mechanism.*—(a) Depress ejector lock with point of a dummy cartridge. Hold thumb in front of magazine catch spring to prevent it from flying out and then slide ejector out of its seat. Remove magazine catch spring. Remove magazine catch pin, lift out magazine catch and magazine release.

(b) Insert trigger guard retaining pin spring under sear spring above connector stop. Pry up, pressing against sear spring with thumb, and pull it out to rear. Push out trigger pin. The trigger pin must always be removed before sear pin in order that tension, of counterrecoil spring will always be on sear pin. Remove trigger and connector through top of trigger guard. Push out sear pin with the recoil spring

guide. Remove sear and sear release stop lever. Separate sear release stop lever from sear. Pry up on sear carrier and lift out sear carrier and counterrecoil spring. Remove

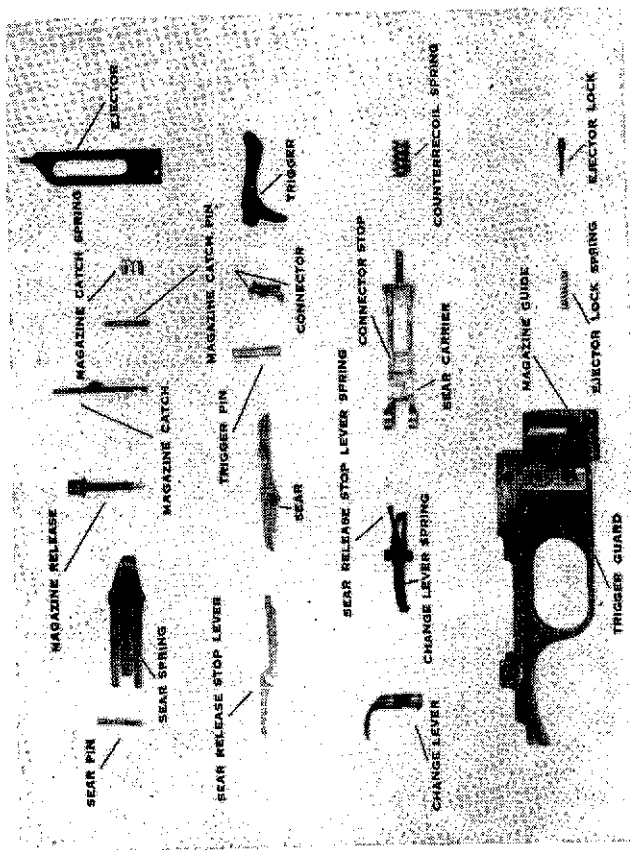

FIGURE 3.—Trigger guard group.

change lever spring by prying bent end out of its seat using rounded end of sear spring and moving change lever from front to rear. When clear of change lever, push it out the

rest of the way by pressing with thumb against base of sear release stop lever spring. Pull out change lever.

(3) *Bipod assembly*.—Unscrew two bipod leg clamp wing screws. Remove right and left bipod leg assemblies. Remove two bipod clamp leg guides. Unscrew two bipod body wing screws. Remove right and left bipod leg tubes from bipod body.

■ 9. ASSEMBLING THE RIFLE.—The rifle and its component parts are assembled in the reverse order of their disassembly as given in paragraph 8b. The following detailed explanation of the method of assembling the rifle is furnished as an aid to instructors:

a. *Bipod assembly*.—Replace bipod leg tubes in bipod body so that unthreaded holes of bipod leg clamps are facing

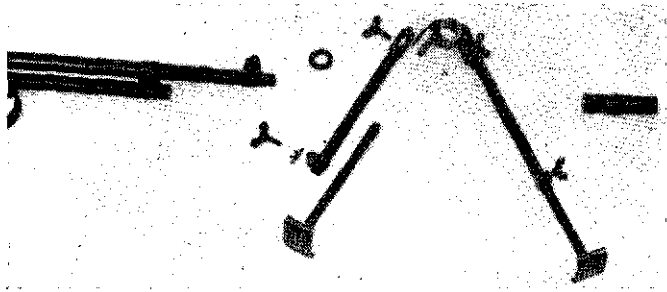

FIGURE 4.—Bipod group.

outward. Replace two bipod body wing screws. Replace two bipod clamp leg guides in their slots on right and left bipod legs. Replace bipod leg assemblies in bipod leg tubes. Align U-shaped opening of bipod clamp leg guides with holes in bipod leg clamps and replace bipod leg clamp wing screws.

b. *Trigger mechanism*.—(1) Replace change lever. Insert ears of change lever spring in slots in trigger guard, sear release stop lever spring being up and to rear, push spring forward into place. Replace counterrecoil spring on counterrecoil spring guide (front of sear carrier). Insert counterrecoil spring guide into its seat. Brace forward end of trigger guard against an immovable object, and with thumbs of right

and left hands pressing on rear of sear carrier push sear carrier forward until rear end is held by ears of change lever spring. Hold sear so that slotted portion of cammed end of sear is down. Insert short end of sear release stop lever upward through slot in forward part of sear taking care that notched end is down. Aline sear pin hole of sear release stop lever with sear pin hole in sear. Replace sear and sear release stop lever and force recoil spring guide through sufficiently so as to aline holes in sear release stop lever, sear, sear carrier, and trigger guard for sear pin. By slight pressure on recoil spring guide push sear carrier forward against counterrecoil spring, thus permitting sear pin to be seated easily in sear pin hole. The sear pin must always be replaced before trigger pin in order that tension of counterrecoil spring will always be on sear pin. Replace trigger and trigger pin.

(2) Holding connector so that its head is in rear of connector stop and toe is down and to rear, depress rear end of sear and drop connector into its place in trigger. Engage sides of sear spring in recesses and press down and forward on sear spring with thumb of right hand until front end of spring rests in depression stop. Take care to see that outside prongs of sear spring rest on their seat on sear and that middle prong rides freely in slot formed by walls of sear carrier. If middle prong rests on one of walls, instead of riding freely between them, trigger mechanism will not function when barrel is inclined below horizontal.

(3) Replace magazine release, magazine catch, and magazine catch pin. Replace magazine catch spring. Insert ejector into recess and move it down until it is flush with magazine catch spring. Compress magazine catch spring in its seat and move ejector down until it is fully home and ejector lock is in its position.

(4) After trigger mechanism has been assembled, turn change lever to forward position, and pull trigger. If connector will not rise, it is not in place correctly. It should rise and snap out from under sear. If connector will rise but does not raise sear, sear spring is weak and should be replaced.

*c. Operating group.*—Replace extractor spring (78). Replace extractor (77) into its seat in bolt. Replace bolt link (82) and bolt link pin (83) with shoulder of link against flat surface of bolt lock (80). Lift bolt lock and replace firing pin (76). Lay rifle barrel down and pointing to left so that rifle is resting on barrel and rear sight. With bolt mechanism held in a perpendicular position insert it in receiver, forcing end of bolt under ends of bolt supports, and then press bolt mechanism down so as to lie flat in its place. Push bolt mechanism forward, swing bolt link down, then replace slide (45) and push all the way back. With hammer (85) resting between thumb and forefinger, lower and seat it properly in its seat in slide. Push bolt lock fully into its locking recess and push slide forward. With thumb and forefinger of right hand, align hammer pin holes of bolt link, hammer, and slide with hammer pin hole in side of receiver. The recoil spring guide will be found a convenient aid in this operation. Insert hammer pin (86) to right until only  $\frac{1}{4}$  inch of hammer pin protrudes from receiver. Replace operating handle (88). Tap end of protruding hammer pin with sufficient force to drive it home. Replace recoil spring (40) and guide (41). With end of index finger on checkered end of recoil spring guide head, turn it until it is properly seated. Holding right thumb against forward end of receiver will facilitate this operation. Replace trigger guard group and trigger guard retaining pin (11). Cock the rifle. Slide gas cylinder tube and forearm (118) to rear of gas piston. Replace gas cylinder tube retaining pin (53). Replace flash hider spring lock washer on muzzle. Replace bipod assembly on flash hider and screw flash hider onto muzzle. Test rifle by pulling trigger.

■ 10. TO REMOVE FIRING PIN WITHOUT DISASSEMBLING.—To remove firing pin, lay rifle on table, barrel down, muzzle to front. Remove trigger mechanism. Place rim of cartridge under bolt guide (fig. 5 ①). Pull operating handle to rear and hold mechanism back. Steady cartridge with thumb and forefinger of right hand (fig. 5 ②). It may be necessary to exert slight downward pressure on nose of cartridge in order to pull bolt guide out far enough to free bolt. Push down on bolt link, causing bolt to break at bolt lock pin

(fig. 5 ③). Allow mechanism to go forward until it stops. Change firing pin. Pull operating handle to rear again and push bolt into position (fig. 5 ④).

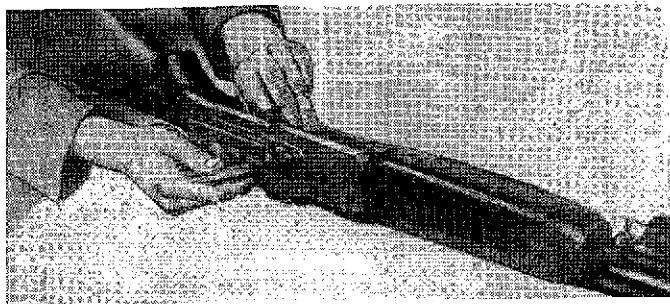

①

■ 11. TO REMOVE AND REPLACE EXTRACTOR WITHOUT DISASSEMBLING.—*a. Removal.*—Draw mechanism to rear and insert an empty cartridge case between bolt and chamber, exposing extractor (fig. 6 ①). Lay rifle on its side so that ejection opening is up. With forefinger of left hand, force out claw

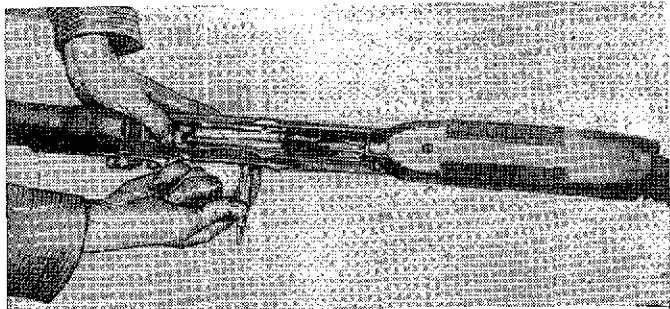

②

of extractor, then place point of cartridge behind extractor shoulder and pry it forward until extractor is free of the recess (fig. 6 ②). Remove extractor spring.

*b. Replacement.*—Insert short end of extractor spring in hole in shank of extractor so that long end of spring is along



slot in extractor. Insert extractor and spring in end of bolt and push them into position (fig. 6 ③). Remove empty cartridge case.

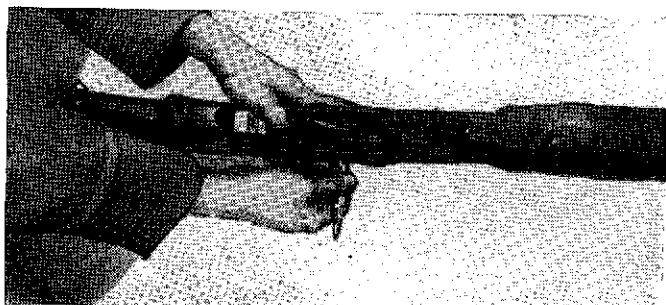

③

■ 12. DISASSEMBLING AND ASSEMBLING THE MAGAZINE.—Raise rear end of magazine base until indentations on it are clear, then slide it to rear. The magazine follower and spring will then fall out. (See fig. 7.) It is assembled in reverse order. (See fig. 8.)

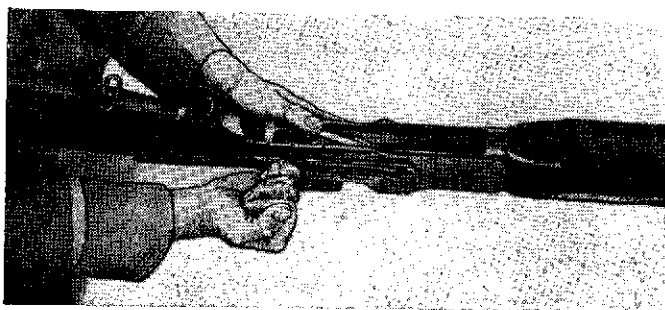

④

FIGURE 5.—Removing firing pin without disassembling rifle.

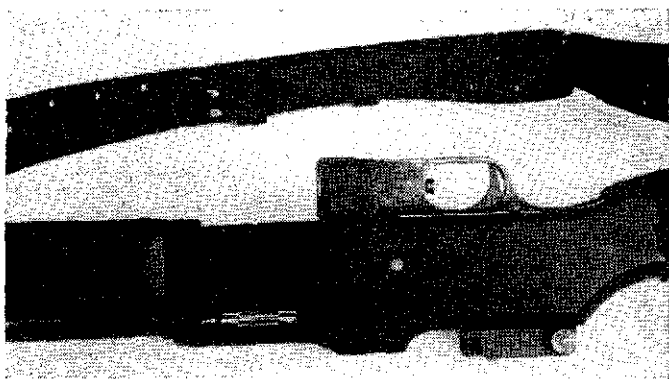

①

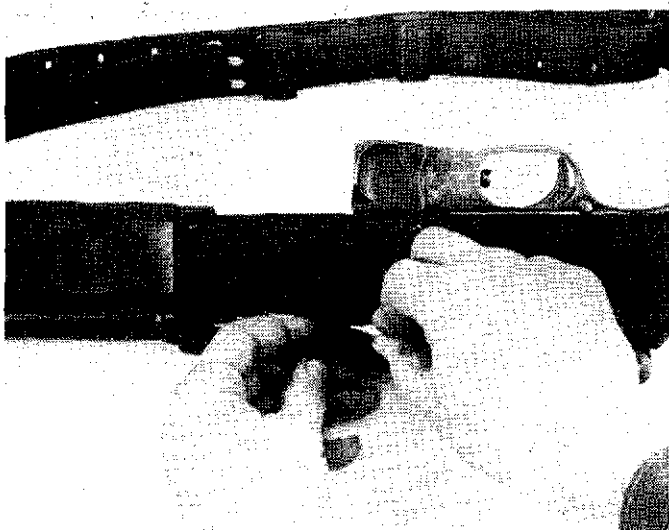

②

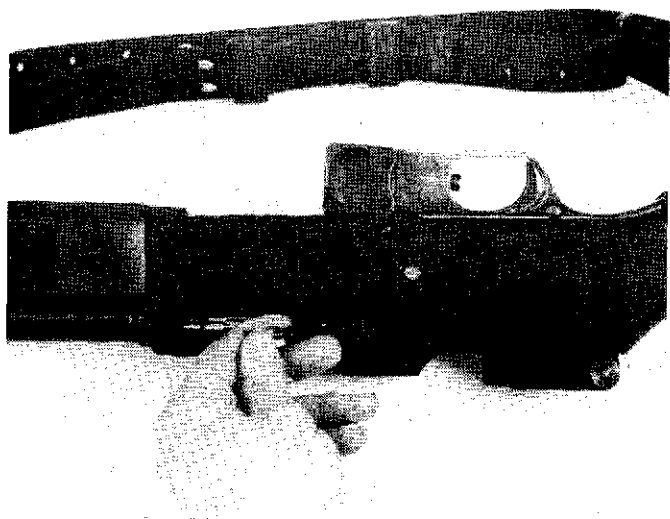

⊙

FIGURE 6.—Removing extractor without disassembling rifle.

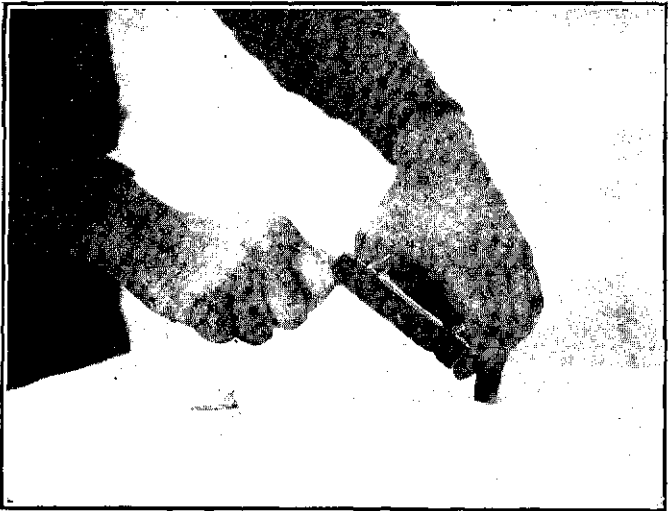

- ① With point of a cartridge raise rear end of magazine base until indentations are clear to permit withdrawal. Then slide base to rear.



- ② Pull out magazine spring and shake out follower. For assembling, insert follower and magazine spring.

FIGURE 7.—Disassembling magazine.

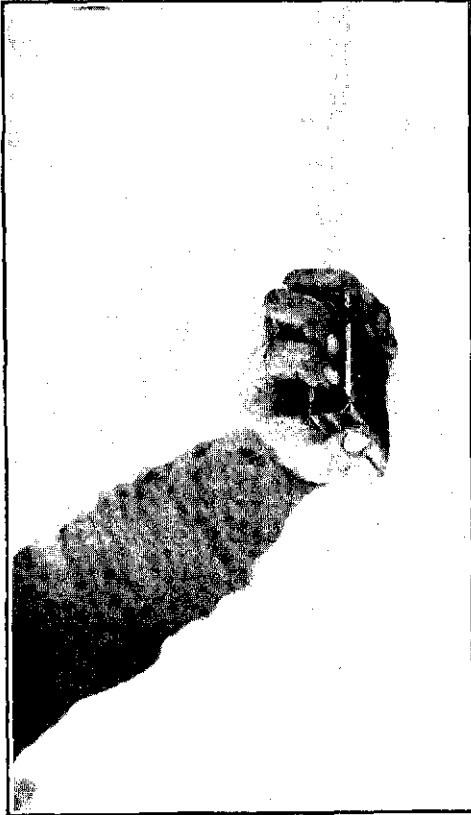

① Compress magazine spring into position.



③ With left hand hold magazine spring in position. Slide magazine base fully home.

FIGURE 8.—Assembling magazine.

## SECTION III

## CARE AND CLEANING

■ 13. GENERAL.—*a. Scope.*—(1) Care and cleaning includes the care of the automatic rifle necessary to preserve its condition and appearance under all conditions and at all times. Automatic rifles in the hands of troops should be inspected daily to insure proper condition and cleanliness.

(2) Automatic rifles should be disassembled only to the extent necessary for cleaning and proper lubrication.

*b. Lubrication and lubricants.*—(1) Proper oiling is second in importance only to intelligent cleaning. It is a vital necessity for the working parts, but the oil should be used sparingly; wiping with a well-oiled rag is the best method. Oil all bearing surfaces of the rifle before firing.

(2) If the rifle is to be fired in areas where the temperature is 45° F. or above, sperm oil (U. S. A. Spec. 2-45A) should be used for oiling when available. When not available, motor oil, weight 20, or any light-grade machine oil may be used in an emergency.

(3) If the rifle is to be fired in areas where the temperature is below 45° F., aircraft instrument and machine gun lubricating oil (U. S. A. Spec. 2-27D) should be used.

*c. Cleaning.*—To clean the automatic rifle, swab the bore with an oily flannel patch. Repeat with dry patches until several successive patches have come out clean. (For cleaning the bore after firing see par. 14c.) Push a patch dampened with oil through the bore to protect its surface. Dust out all screw heads and crevices with a small cleaning brush or small stick. Wipe all metal surfaces with a dry cloth to remove moisture, perspiration, and dirt. Wipe the outer surfaces of the automatic rifle, including the forearm, with a lightly oiled cloth, then clean with a soft, dry one. Immediately after cleaning, wipe all the metal parts with a lightly oiled cloth. This protective film on all metal parts will be maintained at all times. At least once a month, and always after the stock and forearm have become wet, they should be rubbed thoroughly with a little linseed oil in the palm of the hand. Rub oil in until dry. Use only castile soap or saddle soap for cleaning or softening the sling.

■ 14. ADDITIONAL RULES FOR CARE OF RIFLE.—*a. Preparatory to firing.*—(1) Remove the protective film of oil from bore and chamber.

(2) Work slide back and forth several times to see that it moves freely.

(3) Verify proper setting of gas port.

(4) Test trigger mechanism at "safe."

(5) Examine magazines. It is imperative that magazines be given the best of care and kept in perfect condition. They should be disassembled, wiped clean and dry, and thinly coated with oil. Much dirt gets into them through careless handling on the ground during range or other firing. They must be kept free from dirt and rust which hinder their operation by making the spring and follower stick. Care must be exercised in the handling of magazines to avoid denting or bending them. The greatest possible care should be taken to prevent any damage to the lips of the magazine or to the notch for the magazine catch.

*b. During firing.*—(1) Keep bore free from dust, dirt, mud, or snow.

(2) Keep chamber free from oil or dirt.

(3) Keep moving parts oiled.

(4) Clean bore and gas system as frequently as opportunity during cessation of fire permits. The neglect of this precaution is a frequent cause of stoppages.

(5) Clean chamber frequently while still hot with chamber brush by inserting it through the ejection opening in the receiver.

*c. After firing.*—(1) The bore of the rifle will be thoroughly cleaned by the evening of the day on which it is fired, and similarly cleaned for the next 3 days.

(2) The bore is cleaned after firing by swabbing the bore with a flannel cleaning patch saturated with hot water and sal soda or issue soap solution. Repeat with several patches. Plain water, hot or cold, should be used when soda or soap are lacking. While still wet, run the metal brush through the bore several times. Follow this with dry patches until several patches come out clean and dry, then push a patch saturated with oil through the bore to protect its surface.



(3) Clean the chamber with the chamber cleaning brush, wipe clean with a cloth, and oil lightly.

(4) Clean the gas system by first disassembling the rifle. Remove the gas cylinder. Insert the smooth end of the body of the gas cylinder tool into the gas cylinder. As it is advanced toward the cylinder head, turn it to the right. As it reaches the head, apply additional pressure to the tool and give it a few turns to cut the carbon from the inside surface of the piston head. Withdraw and reverse the tool. Using the recess cutter as a gage, remove the carbon from the recesses at the forward end of the interior of the gas cylinder. With the drift point, clean the gas ports in the barrel, gas cylinder tube, and gas cylinder. Scrape the carbon from the face of the piston with the front cutting edge of the tool body and remove the deposit from between the piston rings with the drift point. Wash with hot water and soap or sal soda solution (if not available, use plain water), dry thoroughly, and oil lightly.

(5) Clean magazines and bipod assembly by disassembling, wiping, oiling, and reassembling.

■ 15. STORAGE.—*a. Preparation for long-term storage.*—Automatic rifles should be cleaned and prepared with particular care. The bore, all parts of the mechanism, and the exterior of the rifles should be thoroughly cleaned and then thoroughly dried with rags. In damp climates particular care must be taken to see that the rags are dry. After drying a part, the bare hands should not touch that part. Special care should be taken to insure that the gas system is thoroughly cleaned and that the gas ports are free from fouling. All metal parts should then be heavily coated with rust-preventive compound. Then handling the rifle by the stock and forearm only, it should be placed in the packing chest, the wooden supports at the butt and muzzle having previously been painted with rust-preventive compound. A rifle will not be placed in storage contained in a cloth or other cover or with a plug in the bore. Such articles collect moisture which causes the weapon to rust.

*b. Cleaning when received from long-term storage.*—Automatic rifles received from storage are completely coated with rust-preventive compound. Use dry-cleaning solvent to re-

move all traces of this compound, particular care being taken that the gas system, gas ports, firing pin, and all recesses in which springs or plungers operate are cleaned thoroughly. After using the dry-cleaning solvent, make sure it is completely removed from all parts by wiping with light-colored cloths until no staining of the cloth occurs. The bore and chamber of the barrel must be thoroughly cleaned. All surfaces having been thoroughly cleaned, they should then be protected with a thin film of lubricating oil applied with a rag.

**NOTE.**—Failure to clean the gas system, the firing pin, and the recess in the bolt in which it operates may result in gun failure at normal temperatures and will most certainly result in serious malfunctions if the rifles are operated in low temperature areas, as rust-preventive compound and other foreign matter will cause the lubricating oil to congeal on the mechanism.

#### SECTION IV

### FUNCTIONING

■ 16. **GENERAL.**—*a. Object.*—This section is designed to provide a nontechnical description of the functioning of the rifle. The object of instruction in this subject is to lead the soldier to an understanding of the simple functioning of his weapon without emphasis on memorizing the matter of the text.

*b. When taken up.*—Instruction in functioning will be taken up after instruction in the disassembly, assembly, care and cleaning of the rifle.

■ 17. **USE OF DUMMY CARTRIDGES.**—The corrugated type of dummy cartridge (cal. .30, M1906) may be used for instruction in functioning. The use of the slotted type of dummy cartridge (range, cal. .30, M1) is prohibited. Special care must be exercised in the use of dummy cartridges that they do not introduce dirt or grit into the chamber of the rifle.

■ 18. **MECHANICAL MEANS OF FUNCTIONING.**—All automatic weapons must have mechanical means for performing the following functions: extraction, ejection, feeding, locking the breech while there is a high pressure in the bore, and igniting the cartridge. Operations such as extraction and ejection are performed by various cams, lugs, and springs, and the energy necessary to perform this work and to overcome friction in

the rifle is derived from the explosion of the powder in the chamber.

■ 19. CYCLE.—*a.* The functioning of the automatic rifle is divided into two phases based on the operation of the mechanism when a shot is fired. These two phases are the rearward

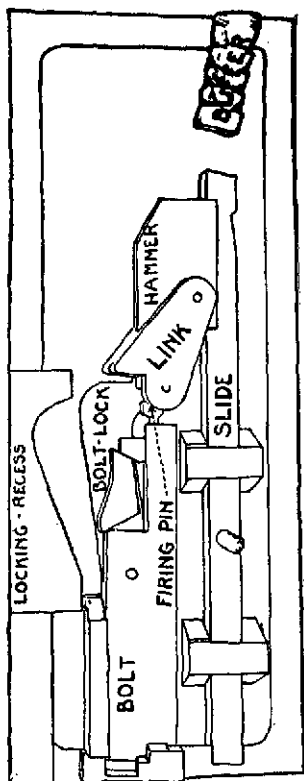

FIGURE 9.—Bolt action.

movement and the forward movement. The ignition of the cartridge in the chamber marks the division of the two phases.

*b.* The operations which take place in the rearward movement are—

- (1) Action of gas.

- (2) Movement of slide to rear.
- (3) Unlocking.
- (4) Withdrawal of firing pin.
- (5) Extraction.
- (6) Ejection.
- (7) Termination of first phase.

c. The operations which take place in the forward movement are—

- (1) Action of recoil spring.
- (2) Feeding.
- (3) Locking.
- (4) Ignition.
- (5) Termination of second phase.

■ 20. DESCRIPTION OF CYCLE.—*a. Rearward movement.*—(1) *Action of gas.*—A cartridge having been ignited, the bullet under the pressure of the expanding powder gases travels through the barrel, and when it reaches a point 6 inches from the muzzle it passes a port in the bottom of the barrel. The barrel pressure, which at this instant is still very high, seeks this first natural vent. Alined with the barrel port are other similar ports in the gas cylinder tube bracket, gas cylinder tube, and gas cylinder. The port in the gas cylinder is the smallest and serves to throttle the barrel pressure. The port in the gas cylinder leads radially into a well about  $\frac{1}{8}$  inch in diameter in the head of the gas cylinder. The throttled barrel pressure is conducted through this well to the gas piston plug. This pressure acts on the piston for the very short time which it takes for the bullet to travel the 6 inches of distance from the barrel port to the muzzle. Its effect is that of a sudden severe blow on the piston plug. Under the impact of this blow, the gas piston is driven to the rear carrying the slide with it. When the piston has traveled about  $\frac{9}{16}$  inch backward, the bearing rings on its head and the gas piston plug pass out of the cylinder. The gas expands around the piston head and into the gas cylinder tube and is exhausted through the six portholes in the tube. The gas is prevented from traveling back through the gas cylinder tube by the two rings on the piston, about  $\frac{5}{8}$  inch apart and  $1\frac{1}{4}$  inches from the piston head. These rings also serve as bear-

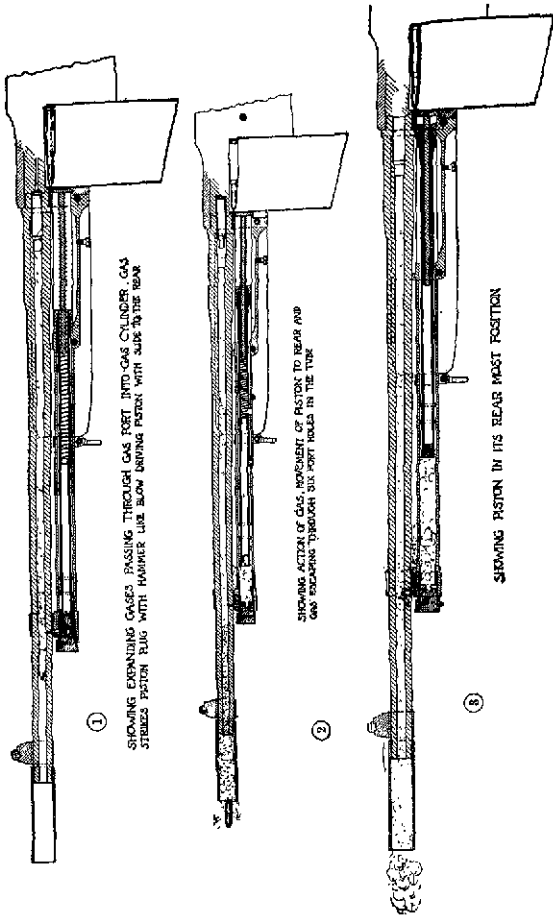

FIGURE 10.--Action of gas on piston.

ings to hold the front end of the piston in the center of the gas cylinder tube after the piston head has passed out of the gas cylinder.

(2) *The slide.*—As the piston is forced back it carries the slide with it. The first and the immediate result of the backward movement of the slide is to begin the compression of the recoil spring, thereby storing energy for the forward action.

(3) *Unlocking.*—The hammer pin is slightly in advance of the bolt link pin about 0.19 inch. The center rib of the hammer is very slightly in rear of the head of the firing pin. When the slide begins its motion to the rear it imparts no motion whatever to the bolt and bolt lock. The slide moves back 0.19 inch, and its only effect during this travel is to carry the hammer from the firing pin and the hammer pin directly under the bolt link pin. At this point the unlocking begins, the bolt link revolves forward about the hammer pin, drawing the bolt lock down and to the rear. The motion of the lock and bolt, which is zero at the instant the hammer pin passes under the bolt link pin, accelerates from this point until the slide has traveled about 1.2 inches, at which latter point the bolt lock is drawn completely down out of the locking recess and away from the locking shoulder of the receiver. It is now supported in front on the bolt supports. The front upper shoulder of the bolt link has revolved forward and bears upon the locking shoulder of the bolt lock. These two influences prevent the bolt lock from revolving down below the line of backward travel of the bolt.

(4) *Withdrawal of firing pin.*—As the bolt lock revolves down from its locked position, a cam surface in a slot in the rear bottom side of the bolt lock comes in contact with a similar cam surface on the firing pin lug. This action cams the firing pin from the face of the bolt.

(5) *Extraction.*—The backward motion of the bolt begins when the bolt lock has been drawn down so that the circular cam surface on its under side is operating on the rear shoulders of the bolt supports. This produces a strong lever action which slowly loosens the cartridge case. The backward travel of the bolt has been slight, only about  $\frac{5}{32}$  inch when the

firing pin is withdrawn; its travel is about  $1\frac{1}{32}$  inch when the bolt lock is completely drawn down. From this point the bolt moves to the rear, drawn by the bolt lock and bolt link, with the same speed as the slide and carries with it the empty cartridge case which is held firmly in its seat on the face of the bolt by the extractor. The extractor is on the upper right side of the bolt next to the ejection opening in the receiver. A slot cut in the left side of the bolt lock near the back end passes over the bolt guide, which supports the bolt lock and bolt when they are in the rear position.

(6) *Ejection.*—When the slide reaches a point about  $\frac{1}{4}$  inch from the end of its travel, the base of the cartridge case strikes the ejector. This action causes the cartridge case to be pivoted with considerable force about the extractor and through the ejection opening in the receiver. The front end of the cartridge case passes first out of the receiver and is pivoted so that it strikes the outside of the receiver at a point about 1 inch in rear of the ejection opening. It rebounds from the receiver toward the right front.

(7) *Termination of rearward movement.*—The rearward motion terminates when the rear end of the slide strikes the buffer head and sear release. The slide, under the action of the recoil spring, moves forward  $\frac{1}{16}$  inch after striking the buffer head and sear release. If the sear nose is not depressed, it engages the sear notch on the slide and the piece is cocked for the next burst or shot.

NOTE.—The motion of the bolt, bolt lock, and bolt link mechanism began slowly at first and did not attain the speed of the slide until the latter had traveled about  $1\frac{1}{4}$  inches backward. This is a very important characteristic of the rifle, since on this account the mechanism is not subjected to an excess strain due to a sudden start at the instant the gas impinges upon the piston. This slow start delays the opening of the chamber sufficiently to allow the high barrel pressure to decrease.

b. *Forward movement.*—(1) *Action of recoil spring.*—The sear nose is depressed, disengaging the sear, and the slide moves forward under the action of the recoil spring. The position of the bolt link pin is slightly below a line joining the bolt lock pin and the hammer pin; therefore as the slide starts forward the joint at the bolt link pin has a tendency to buckle downward. It is prevented from doing this by the tail of the feed rib on the bolt which extends backward under

the bolt lock, also by the upper front shoulder of the bolt link being in contact with the locking surface of the bolt lock. Since the joint cannot buckle, the entire mechanism moves forward with the slide. When it has traveled about  $\frac{1}{4}$  inch, the front end of the feed rib impinges on the base of the top cartridge, which the magazine spring and lips are holding up in its path.

(2) *Feeding.*—The cartridge is carried forward about  $\frac{1}{4}$  inch, when the nose of the bullet strikes the bullet ramp or guide on the breech of barrel and is deflected upward toward the chamber. This action also guides the front end of the cartridge from under the magazine lips. The base of the cartridge approaches the center of the magazine, where the lips are cut away and the opening enlarged, and at this point is forced out of the magazine by the magazine spring. The base of the cartridge slides across the face of the bolt and under the extractor. Should the cartridge fail to slide under the extractor, the extractor will snap over its head as the bolt reaches the forward position. When the cartridge is released by the magazine, the nose of the bullet is so far in the chamber that it is guided by the chamber from this point on.

(3) *Locking.*—When the slide is about 2 inches from its forward position, the circular cam surface on the under side of the bolt lock begins to ride over the rear shoulders of the bolt supports, and the rear end of the bolt lock is cammed upward. The bolt link pin passes up above the line joining the bolt lock pin and hammer pin. The joint at the bolt link pin now has a tendency to buckle upward, and the bolt lock being opposite the locking recess in the receiver is free to and does pivot upward about the bolt lock pin. The bolt link revolves upward about the hammer pin, forcing the bolt lock up, and a rounded surface on the bolt lock just above the locking face slips over the locking shoulder in the receiver, giving the lock a lever action which forces the bolt home to its final position. The two locking surfaces on the bolt lock and the receiver register as the hammer pin passes under the bolt link pin.

(4) *Igniting the cartridge.*—The lug on the firing pin is buried in the slot on the under side of the bolt lock at all



times except when the bolt is locked in the forward position. Therefore, the firing pin is locked away from the face of the bolt during all the rearward and forward motion of the bolt. When the hammer pin passes under the bolt link pin, the firing pin has been released by the bolt lock. The slide and hammer move forward about  $\frac{1}{8}$  inch farther, and the center rib of the hammer strikes the head of the firing pin, driving it forward and igniting the cartridge.

(5) *Termination of second phase.*—The forward end of the slide strikes a shoulder at the rear end of the gas cylinder tube which terminates the forward motion. The forward motion is not terminated by the hammer on the firing pin. This can be seen by examining the head of the firing pin when the gas cylinder tube is assembled to the receiver, and the bolt mechanism is in the forward position. The firing pin has still about  $\frac{1}{8}$ -inch clearance from its extreme forward position.

NOTE.—The locking shoulder of the receiver is inclined forward. Its surface is perpendicular to the line through the bolt lock which the shock of the explosion follows; therefore the force of this shock is exerted squarely against the normal surface. The speed of the bolt mechanism is slowed down gradually from the instant that the bolt lock starts to rise until the hammer pin passes under the bolt link pin, when the speed is zero.

■ 21. FUNCTIONING OF COMBINATION BUFFER AND RATE REDUCING MECHANISM.—*a. Parts.*—The buffer and rate reducing mechanism consists of the following parts in the order given from front to rear:

(1) Buffer tube, which has four splined slots on the inside of the forward end for use in positioning the buffer head. One of these slots only is used to anchor the buffer tube to the buffer head by means of the buffer key.

(2) Buffer head.

(3) Sear release, inserted in buffer head.

(4) Buffer key, which holds sear release in buffer head and anchors buffer tube to buffer head.

(5) Brass friction cup with concave interior which is split to allow for expansion; and a steel cone to fit into the cup. Four of these cups and cones are placed one after the other in series.

(6) Buffer spring.

(7) Actuator, inside of cups, cones, and buffer spring.



①

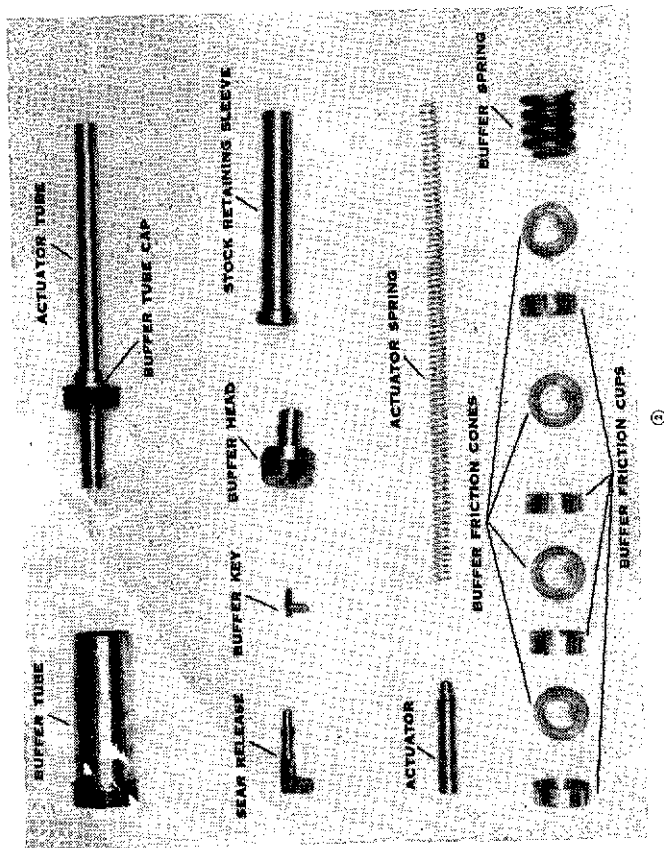

②

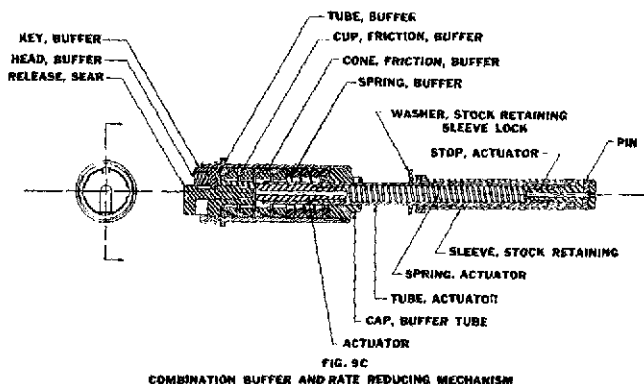

②

FIGURE 11.—Combination buffer and rate reducing mechanism.

- (8) Buffer tube cap.
- (9) Actuator tube.
- (10) Actuator spring, inside actuator tube.
- (11) Stock retaining sleeve lock washer.
- (12) Stock retaining sleeve.
- (13) Actuator stop.
- (14) Pin.

b. *Action*.—(1) When the automatic rifle is fired at the slow cyclic rate, the buffer head and sear release, struck by the rear end of the slide, move to the rear. The buffer head forces the friction cups over the cones, causing them to expand tightly against the tube, consequently producing considerable friction as the cups move back and compress the buffer spring. Thus the rearward action of the slide is checked gradually and there is practically no rebound. The buffer spring returns the buffer head and friction cups and cones to their original positions. After striking the buffer head and sear release, the slide moves forward until it is engaged by the sear. The delayed release of the sear is then accomplished as follows: The sear release when struck by the slide in turn strikes the actuator in the buffer. The actuator is driven to the rear inside the actuator tube against the actuator spring. It returns under the force of

expansion of the actuator spring to drive the sear release forward against the camming surface on the rear of the sear, thus releasing the sear and permitting the rifle to continue its cycle. (See par. 23n.)

(2) When the rifle is fired at the normal cyclic rate, the functioning of the combination buffer and rate reducing mechanism is the same as explained for the slow cyclic rate in (1) above except that the sear release is prevented from engaging the camming surface on the rear end of the sear by the sear release stop lever. (See par. 23m.)

■ 22. FUNCTIONING OF TRIGGER MECHANISM.—a. The trigger mechanism has three settings:

(1) *Normal cyclic rate (A)*.—When so set the sear is depressed as long as the trigger is held back, and the rifle will continue firing at a cyclic rate of about 550 rounds per minute until the magazine is emptied.

(2) *Slow cyclic rate (F)*.—When so set the sear is depressed, thereby disengaging the sear and sear notch when the trigger is pulled, but the mechanism is so constructed that the sear rises and engages in the sear notch when the slide comes back again, and the sear notch will not disengage until the sear release in the buffer depresses the rear end of the sear by riding over the cammed end of the sear or the trigger is fully released and then pulled. With this setting, the rifle fires one shot for each pull and quick release of the trigger or a slow cyclic rate of 350 rounds per minute for the length of time the trigger is held completely to the rear.

(3) *Safe (S)*.—When so set, the sear cannot be released from the sear notch by pulling the trigger.

b. The action of the trigger mechanism is taken up in phases and should be followed on the mechanism itself as the explanation proceeds. Have the trigger guard disassembled completely. Study the shape of the change lever and note the following:

(1) It is a bar about  $\frac{1}{4}$  inch in diameter.

(2) It has three shallow longitudinal slots cut on top of the bar as the handle is held vertically.

(3) The side of the bar is slotted in such a way as to leave a little tongue of metal in the center and at the lower edge of the slot.

■ 23. SETTING CHANGE LEVER.—*a.* Assemble the change lever and spring to the trigger guard. The toe of the change lever spring is seated in one of the longitudinal slots on the change lever, and as the lever is turned from one position to another it seats in the other slots. The only function of the forward end of the spring and the longitudinal slots is to hold the change lever in the position in which it is set.

*b.* Assemble the trigger and pin to the guard.

*c.* Turn the change lever to rear or safe position. In this position the slot is turned slightly upward, and the full surface of the bar is on the bottom. Pull the trigger. The rear top end of the trigger is slotted longitudinally, and the metal on each side of the slot forms two shoulders which rise against the bottom of the change lever bar.

*d.* Push the change lever over to the vertical position, which is the full or normal cyclic rate setting. Pull the trigger. The slot in the change lever is now turned to the front, and the two shoulders of the trigger, which before engaged the full surface of the change lever bar, now are free to pass up into the slot of the change lever; also the tongue of metal on the bottom of the change lever slot passes through the longitudinal slot in the end of the trigger.

*e.* Push the change lever forward to the slow cyclic rate position.

*f.* The slot is now turned partially down and when the trigger is pulled the rear end of the trigger passes up into the change lever slot; also the tongue of metal in the bottom of the change lever slot is now turned back and does not pass through the slot in the end of the trigger as it did in the normal cyclic rate position.

*g.* Observe the shape of the connector. It is shaped like a boot with a toe and heel. It has a flat surface that slopes down and toward the front from the head (sear spring ramp). In rear of the head the profile extends straight downward for about  $\frac{1}{8}$  inch, then slopes slightly to the rear for 0.12 inch (sear carrier ramp). This last slope is used in a cam action to be explained later. The function of the narrow, flat top

surface of the connector is to raise the forward end of the sear until cammed out from under the latter.

*h.* Place the connector on the connector pin and set change lever to safe; pull the trigger. The connector is not raised for the obvious reason that the trigger itself cannot be raised because the change lever bar is in its way.

*i.* Turn the change lever to the normal cyclic rate position; pull the trigger. The head of the connector is raised and held in a vertical position and cannot be tipped forward. The tongue on the change lever engages the toe of the connector as the trigger is pulled and holds the connector upright.

*j.* Turn the change lever to the slow cyclic rate position; pull the trigger. The tongue on the change lever now does not engage the toe of the connector, and the head of the connector can now be tipped forward.

*k.* Note the cross pin on the sear carrier called the connector stop; also note that just in rear of the connector stop and on the underside of the sear carrier is an inclined surface sloping upward in the metal which joins the two sides of the sear carrier. This surface has a cam action with the above-mentioned surface of the connector.

*l.* Completely assemble the trigger mechanism.

*m.* Note that the center leaf of the sear spring presses on the front sloping surface of the connector and tends to press the head of the connector backward. Note that the rear end of the sear release stop lever prevents the sear release from engaging the camming surface on the rear end of the sear except when it is depressed to its lower position by pressing the trigger with the change lever set for the slow cyclic rate. Set the change lever on safe and pull the trigger. The head of the connector is not raised above the sear carrier for reasons given previously. Therefore, the sear nose is not depressed and hence the safe position. Change over to the normal cyclic rate position and pull the trigger; the head of the connector is raised and held in the vertical position thus depressing the rear of the sear. The rear end of the sear release stop lever is partially depressed but is still in its raised position and serves only to prevent the sear release in the buffer assembly from engaging the camming surface on the rear of the sear. The rear of the sear remains in the

depressed position, the forward end being raised by the connector. This prevents a re-engagement of the sear so that normal cyclic rate of automatic fire continues until the trigger is released or the ammunition supply is exhausted. It will be noted from the above that the rate reducing mechanism performs no useful function when the gun is firing at the normal cyclic rate. The tongue on the change lever tends to hold the connector vertically, and the ramp on the sear carrier tends to cam the connector forward. The forces exerted by these two parts on the connector are opposed, hence the trigger mechanism is locked when the trigger has been pulled enough to release the slide.

n. Set the change lever for the slow cyclic rate of automatic fire; pull the trigger slowly. At first the head of the connector rises and thereby depresses the sear nose, allowing the slide to go forward. Note that if the press on the trigger is not continued, the sear nose is still depressed, and the rear end of the sear release stop lever is in its upper position thus causing the gun to fire at the normal cyclic rate. If the press of the trigger is continued, the previously mentioned cam surface on the connector comes in contact with the cam surface of the sear carrier, and the head of the connector is cammed forward against the pressure of the center leaf of the sear spring. The connector disengages the forward end of the sear, and the two outside leaves of the sear spring depress it. The forward end of the sear release stop lever is raised and is held in its upper position by the connector. The sear nose is raised up in the path of the slide and engages the sear notch when the slide moves back. The rear end of the sear release stop lever remains in the low position below the camming surface on the rear of the sear thus clearing the camming surface so that the sear release in the buffer is free to act on the camming surface on the sear. This causes the rifle to fire at the slow cyclic rate as long as the trigger is held to the rear. (See par. 21b(1).) When the trigger is released, the center leaf of the sear spring presses the head of the connector downward and back under the forward end of the sear, and the rear end of the sear release stop lever is raised to its upper position by the action

of the sear release stop lever spring. When the trigger is pulled again the action is repeated.

o. In the slow cyclic rate position, the connector stop prevents the head of the connector being tipped so far forward that the sear spring cannot push it back in place when the trigger is released. The only function of the change lever in the slow cyclic rate position is the limiting of the upward travel of the trigger when its upper rear shoulders strike the top of the slot in the change lever, which in this position is turned down.

## SECTION V

### OPERATION

■ 24. GENERAL.—*a. Object.*—This section is designed to give the soldier instruction necessary for the operation of the rifle.

*b. When taken up.*—The operation of the automatic rifle will be taken up at any convenient time after instruction in care and cleaning (sec. III) has been completed.

■ 25. USE OF DUMMY CARTRIDGES.—As prescribed in paragraph 17.

■ 26. TO LOAD THE MAGAZINE.—To load the magazine, place the wide end of the magazine filler over the top of the magazine so that the groove in the magazine filler fits over the catch rib of the magazine. Hold the magazine in the same relative position that it occupies in the rifle, that is, with the catch rib toward the operator. Then insert a clip of cartridges in the guides provided in the filler, and with the right thumb near the base push the cartridges into the magazine. Each magazine will hold 20 rounds. (See fig. 12.)

■ 27. TO LOAD THE RIFLE.—Press the magazine release, withdraw the empty magazine. Hold a loaded magazine with its base in the palm of the right hand, cartridges pointing to the front. Insert the magazine between the sides of the receiver in front of the trigger guard and push it home smartly with the right hand. The magazine can be inserted with the mechanism in either the cocked or forward position. It is, however, ordinarily inserted after the rifle has been cocked.



■ 28. TO UNLOAD THE RIFLE.—Press the magazine release and withdraw the magazine. Let the bolt go forward by pulling the trigger.

■ 29. TO FIRE THE RIFLE.—Select the cyclic rate desired and press the trigger for the length of burst desired. If single

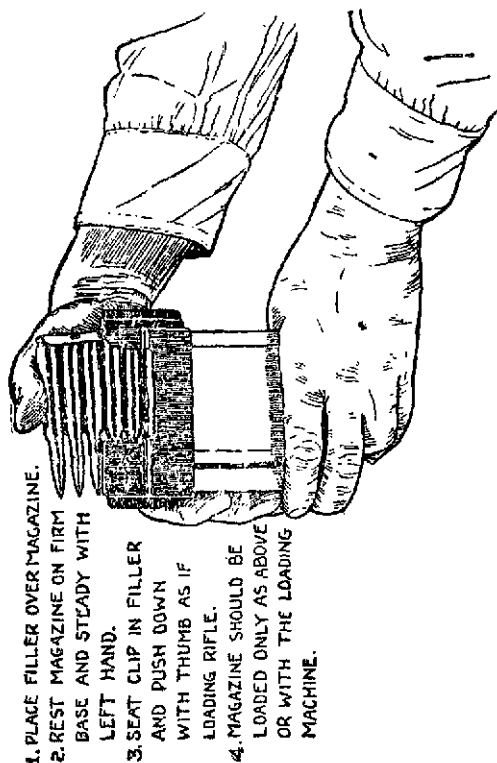

FIGURE 12.—To load the magazine.

shots are desired, set the change lever for the slow cyclic rate; press the trigger and release the pressure upon the trigger immediately upon the release of the bolt for its forward movement.

■ 30. TO SET THE CHANGE LEVER CONTROL.—*a.* For the slow cyclic rate of automatic fire or single shot, push the change lever to the forward position marked "F."

*b.* For the normal rate of automatic fire, set the change lever in the vertical position against the change lever stop, marked "A."

*c.* To set the rifle at safe, depress the change lever stop and pull the change lever rearward until it covers the change lever stop. This position is marked "S." The change stop prevents the accidental setting of the change lever at safe and at the same time allows a quick change from safe to either full automatic or semiautomatic fire.

■ 31. GAS ADJUSTMENT.—*a. General.*—(1) The rifle should normally be operated on the smallest port, and this setting will never be varied unless the rifle shows signs of insufficient gas. To align the smallest port, screw in the gas cylinder with the combination tool until the shoulder of the gas cylinder is about one turn from the corresponding shoulder of the gas cylinder tube and the smallest circle on the cylinder head is toward the barrel. Lock the cylinder in position. If, upon firing, the rifle shows signs of insufficient gas, try setting the cylinder one complete turn on each side of the original setting. As soon as the proper setting has been obtained, the rifleman will carefully note the position so that he can quickly assemble the cylinder to the proper point without trial.

(2) The larger ports are provided for use in case the action of the rifle has been made sluggish through the collection of dirt and grit or the lack of oil under conditions which render prompt correction impracticable. For this reason the threads should be kept clean and oiled and the cylinder free to turn. The extractor, ejector, and the chamber of the barrel should be examined and cleaned and defects corrected when possible. Under adverse conditions, and when signs of insufficient gas become apparent, the cylinder should be unscrewed one-third turn, thus registering the medium circle and aligning the medium port with the gas orifice. Repeat this operation in order to connect the largest port with the barrel.

(3) Excessive friction or dirt may sometimes prevent the complete forward movement of the bolt. This condition may also be caused by the recoil spring having become permanently set or short through continued use while excessively hot; in such cases, replace the recoil spring.

*b. Results of insufficient gas.*—(1) Failure to recoil (usually due to misaligned or excessively clogged gas port or extremely dirty mechanism).

(2) Failure to eject

(3) Weak ejection.

(4) Uncontrolled automatic fire (exceptional).

*c. Results of too much gas.*—(1) Excessive speed causing pounding.

(2) Excessive heat in gas operating mechanism.

■ 32. SAFETY PRECAUTIONS.—*a.* Automatic rifles will not be loaded except when on the firing line and with the muzzle pointed in the direction of the target.

*b.* Automatic rifles will not be carried loaded except in the presence of an enemy or a simulated enemy. Loaded rifles will be carried with the muzzle elevated or to the front.

*c.* Automatic rifles will be carried with the bolt forward at all times except in the presence of an actual enemy.

*d.* Automatic rifles will be assumed to be loaded whenever a magazine is in the receiver.

*e.* Never leave a patch, plug, or other obstruction in the muzzle or bore.

*f.* On the range, rifles are cleared before leaving the firing line. The automatic rifle is cleared by removing the magazine and releasing the bolt to its forward position.

## SECTION VI

### IMMEDIATE ACTION AND STOPPAGES

■ 33. GENERAL.—*a. Object.*—This section is designed to provide necessary instruction in the related subjects of immediate action and stoppages.

*b. When taken up.*—Instruction in immediate action and stoppages will be completed before any firing is done by the individual.

■ 34. IMMEDIATE ACTION.—*a. General.*—Immediate action is the unhesitating application of a probable remedy for a stoppage. Immediate action deals with the method of reducing stoppages and not the cause. It is taught as an unhesitating manual operation to be applied to reduce stoppages without detailed consideration of their causes.

*b. Rifle fails to fire.*—Pull the operating handle completely to the rear and then push it forward. Tap the magazine fully home. Aim and fire. If stoppage recurs, pull back the operating handle slowly to determine position of stoppage, remove the magazine, and apply proper remedy as explained in paragraphs 35*d* and 36.

■ 35. STOPPAGES.—*a. General.*—While immediate action and stoppages are closely related as to subject matter, the former is treated separately to emphasize its importance as an automatic and definite procedure to be applied to overcome stoppages. Proper care of the rifle before, during, and after firing will almost always eliminate stoppages. Stoppages which cannot be remedied by the application of immediate action can best be eliminated if the soldier has an understanding of the functioning of the weapon and the causes of stoppages.

*b. Types.*—(1) Temporary stoppages have been divided into those found in four positions, dependent upon the position where the bolt stops. The position of the stoppage is determined by pulling the operating handle to the rear until it strikes the hammer pin.

(2) Boundaries of the positions are—

(*a*) *First position*, mechanism and operating handle fully closed.

(*b*) *Second position*, operating handle strikes hammer pin anywhere from fully closed to a point where operating handle plunger pin rides over raised shoulders on ribs of operating handle guide way.

(*c*) *Third position*, operating handle strikes hammer pin anywhere from second position to a point directly over "F" of change lever setting.

(*d*) *Fourth position*, operating handle strikes hammer pin anywhere between third position and rear.

**c. Probable causes of stoppages.**—(1) *Failure to extract.*

- (a) Defective extractor.
- (b) Dirt under extractor.
- (c) Dirt in chamber.
- (d) Pitted chamber.
- (e) Weak extractor spring.
- (f) Defective ammunition.

(2) *Failure to eject.*

- (a) Insufficient gas.
- (b) Defective extractor.
- (c) Dirt under extractor.
- (d) Ejector does not fit up close to bolt.
- (e) Ejector binds on bolt.
- (f) Ejector has too much backward play.
- (g) Ejector bent backward or otherwise defective.
- (h) Weak extractor spring.
- (i) Defective ammunition.

(3) *Failure to breech.*

- (a) Dirt between bolt and rear end of barrel.
- (b) Primer in mechanism, generally in front of bolt.
- (c) Defective bolt lock or pin.
- (d) Defective magazine.
- (e) Piston binding.
- (f) Excessive friction.
- (g) Recoil spring too short.

(4) *Insufficient gas.*

- (a) Ports clogged.
  - (b) Poor fit between gas cylinder tube and bracket.
  - (c) Gas leakage around piston (worn cylinder).
  - (d) Piston binding or cylinder dirty.
  - (e) Gas cylinder threaded in too far or vice versa.
- (5) *Ruptured cartridges.*

- (a) Locking surface of bolt lock worn.
- (b) Bearing between bolt and bolt lock worn.
- (c) Face of bolt worn.
- (d) Chamber of barrel worn or pitted.
- (e) Locking shoulder of receiver worn.
- (f) Bolt supports loose or worn.
- (g) Defective ammunition.

*d. Reduction of stoppages.*—(1) *First position stoppage.*—If the stoppage is in the first position, pull operating handle all the way back and watch ejection.

(a) If nothing is ejected, change magazine.

(b) If loaded round is ejected, change firing pin.

(c) If empty cartridge case is ejected, examine the correct adjustment of gas cylinder, turning to the next larger port if necessary.

(2) *Second position stoppage.*—If the stoppage is in the second position, feel for obstruction or bur on face of bolt, in rear end of chamber, in bolt lock recess, or on bolt lock.

(3) *Third position stoppage.*—If the stoppage is in the third position—

(a) If due to a ruptured cartridge, use ruptured cartridge extractor to remove front part of ruptured case from the chamber. If no ruptured cartridge extractor is available, oil and sand nose of bullet, put it in chamber, and let bolt go forward. Pull back operating handle. This will usually extract the ruptured cartridge. Clean and oil chamber after doing this.

(b) If stoppage is not due to a ruptured cartridge, examine face of bolt for obstruction.

(4) *Fourth position stoppage.*—If the stoppage is in the fourth position—

(a) If slide moved after trigger was pulled, use cleaning rod to push cartridge case from the chamber. If this stoppage recurs, clean ammunition, and clean and lightly oil chamber with a patch.

(b) If trigger cannot be pulled or if the slide does not move when trigger is pulled—

1. See if change lever is set on "safe."

2. Take out trigger guard and correct fault in the trigger mechanism.

■ 36. TABLE OF STOPPAGES.—*a.* The following table may be found of value. It includes stoppages outlined in paragraph 35 and others that have not been covered but which may occur.

TABLE OF STOPPAGES

Position	Stoppage	Cause	Remedy in field	
<i>First position</i>	1. Failure to feed.	1. Magazine troubles—	1. a. Push magazine home. b. Change magazine. c. Change magazine. d. Change magazine; clean later. e. Change magazine. f. Change magazine.	
Operating handle fully home.		a. Magazine not fully home.		
		b. Obstruction between lips of magazine and top cartridge.		
		c. Weak magazine spring.		
		d. Magazine dirty.		
		e. Magazine tube or lips dented or bent.		
		f. Magazine catch notch worn.		
		2. Failure to fire.		2. a. Broken or short firing pin. b. Weak recoil spring. c. Excessive friction. d. Faulty ammunition—defective primers or charges.
		3. Insufficient gas.		3. a. Gas cylinder not properly adjusted. b. Gas ports clogged. c. Piston binding, account dirty piston and cylinder.
				2. a. Change firing pin. b. Change recoil spring. c. Clean and oil friction surfaces and chamber. d. Discard ammunition.
3. a. Correct adjustment of gas cylinder. b. Turn cylinder to next larger port. Clean at first opportunity. c. Turn cylinder to next larger port. Clean and oil at first opportunity.				

TABLE OF STOPPAGES—Continued

Position	Stoppage	Cause	Remedy in field
<i>First position—</i> Continued.	3. Insufficient gas—Con.	d. Dirty chamber.  e. Lack of oil-----	d. Turn cylinder to next larger port. Oil chamber. Clean and oil chamber at first opportunity.  e. Oil chamber and friction surfaces.
<i>Second position-----</i> Operating handle strikes hammer pin anywhere from fully closed back to top of raised shoulders on operating handle guideway.	1. Obstruction--  2. Faulty ammunition.	1. Extraneous matter or burs— a. On face of bolt. b. In breech recess where bolt and receiver join. c. On bolt lock. d. In bolt lock recess.  2. Battered round.	1. Feel on face of bolt, in receiver and chamber, on bolt lock, and in bolt lock recess for burs or extraneous matter. Remove extraneous matter or burs.
<i>Third position-----</i> Operating handle strikes hammer pin between second position and point directly over "F" on receiver.	1. Ruptured cartridge.  2. Failure to feed completely.  3. Mechanism wedged tightly.	1. Excessive head space.  2. a. Broken firing pin protruding from face of bolt. b. Other obstruction that prevents base of cartridge from sliding up across face of bolt.  3. Obstruction—extraneous matter between bolt support and bolt lock.	1. Use ruptured cartridge extractor to remove ruptured cartridge case. If recurs, clean and oil chamber.  2. a. Replace firing pin.  b. Remove obstruction.  3. Remove obstruction.



TABLE OF STOPPAGES—Continued

Position	Stoppage	Cause	Remedy in field
<i>Third position—Continued.</i>	4. Faulty ammunition.	4. Battered round.	1. Use cleaning rod to remove empty cartridge case and then— a. Clean and oil chamber. b. Clean face of bolt and extractor. c. Change extractor. d. Change extractor spring.
<i>Fourth position—Operating handle strikes hammer pin between third position and all the way to the rear.</i>	1. Failure to extract.	1. a. Dirty, rusted, or pitted chamber. b. Dirt under extractor. c. Defective extractor. d. Defective extractor spring. e. Defective ammunition—soft rims on cartridges.	
	2. Trigger will not release slide, the rifle being cocked	2. Trouble in trigger mechanism— a. Change lever set on "S." b. Improper assembly which results in failure of center prong of sear spring to push connector back under front end of sear. c. Defective sear spring. d. Defective or lost connector.	2. a. Set change lever on "F" or "A." b. Take out trigger guard and examine. Replace necessary parts and assemble properly. c. Same as b above. d. Same as b above.
	3. Obstruction.	3. Extraneous matter between ejector and bolt.	3. Remove obstruction.

b. In the event of stoppages that are not mentioned above and that cannot be reduced, the rifle should be turned in for examination and repair.

## SECTION VII

### SPARE PARTS AND ACCESSORIES

■ 37. **SPARE PARTS.**—*a.* The parts of any rifle will in time become unserviceable through breakage or wear resulting from continuous usage. For this reason spare parts are provided for replacement of the parts most likely to fail. These parts are for use in making minor repairs and in the general upkeep of the rifle. Twenty-round magazines are also issued as spares, the quantity being based on the allowance of ammunition authorized. Sets of spare parts should be maintained as complete as possible at all times, and should be kept clean and lightly oiled to prevent rust. Whenever a spare part is used to replace a defective part in the rifle, the defective part should be repaired or a new one substituted in the spare parts set. Parts that are carried complete should at all times be correctly assembled and ready for immediate insertion in the rifle. The allowances of spare parts and of 20-round magazines are prescribed in Standard Nomenclature List No. A-4.

b. With the exception of the spare parts mentioned above, repairs or alterations by the using organizations are prohibited.

■ 38. **ACCESSORIES.**—*a. General.*—Accessories include the tools required for disassembling and assembling and for the cleaning and preservation of the rifle. They must not be used for any purpose other than as prescribed. There are a number of accessories the names or general characteristics of which indicate their uses or application. Therefore, detailed description or methods of use of such items are not outlined herein. However, accessories embodying special features or having special uses are described in *b* below.

*b. Special.*—(1) *Brush and thong, caliber .30, complete.*—This consists of the brush, the tip, the weight, and the cord. The thong weight and tip are made of brass and are provided with holes in which the thong cord is knotted. The

tip is provided with a cleaning patch slot and is threaded on the end to receive the brush.

(2) *Brush, chamber cleaning, M1.*—The chamber cleaning brush consists of a curved flat steel handle to which are hinged a chamber cleaning brush at one end and a small bristle dusting brush at the other end.

(3) *Brush, cleaning, caliber .30, M2.*—The brush consists of a brass wire core with bristles and tip. The core is twisted in a spiral and holds the bronze bristles in place. The brass tip, which is threaded for attaching the brush to the cleaning rod, is soldered to the end of the core.

(4) *Case, accessory and spare parts, M1918.*—This is a leather box-shaped case, approximately  $2\frac{1}{4}$  inches wide,  $3\frac{1}{2}$  inches high, and  $5\frac{1}{2}$  inches long. It is used to carry the spare parts and a number of the smaller accessories.

(5) *Case, cleaning rod, M1.*—The case is made of fabric having five pockets, four of which hold the sections of the jointed cleaning rod, M1, while the fifth holds the cleaning brush, caliber .30, M2. The contents are secured in their pockets by a web billet and chape with buckle.

(6) *Extractor, ruptured cartridge, MK. II.*—The ruptured cartridge extractor has the general form of a caliber .30 cartridge. It consists of three parts—the spindle, the head, and the sleeve. To use the ruptured cartridge extractor the live cartridges must be removed from the rifle. The ruptured cartridge extractor is then inserted through the opening of the ruptured cartridge case and pushed forward into the chamber. The bolt is let forward without excessive shock so that the extractor of the rifle engages the ruptured cartridge extractor. As the operating handle is drawn back the ruptured cartridge extractor, holding the ruptured cartridge on its sleeve, is extracted.

(7) *Filler, magazine.*—The magazine filler is a pressed steel adapter which is fitted over the top of an empty magazine when loading. Its method of use is shown in figure 12.

(8) *Rod, cleaning, M2.*—This is a straight rod consisting of two sections permanently fastened together with a swivel joint. The front end has a threaded hole for attaching the cleaning brush and a slot for holding a cleaning patch. The rear end is provided with a tubular steel handle which swivels on the rod.

(9) *Rod, cleaning, jointed, M1.*—This steel rod consists of five sections, the first two of which are permanently fastened together by a swivel joint. The first section has a slot formed for holding a cleaning patch and a threaded hole for attaching the cleaning brush. The rear section is provided with a tubular steel handle which swivels on the rod.

(10) *Sling, gun, M1907.*—The gun sling is fastened to the swivels provided on the rifle. It consists of a long and short strap, either of which may be lengthened or shortened to suit the particular soldier using it.

(11) *Tool, cleaning, gas cylinder.*—This is a special tool for cleaning the gas operating mechanism. The ends of the tool body may be used to scrape carbon from the interior of the gas cylinder and from the face of the gas piston. The drift which is attached to the body may be used to remove carbon deposits from the gas ports and from the grooves of the gas piston. The carbon must be completely removed, but care must be exercised to avoid scoring or damaging the gas cylinder walls or the grooves of the gas piston.

(12) *Tool, combination.*—This tool consists of a steel body having two spanner wrenches and two screw driver ends. The small spanner is used to turn the gas cylinder and the large spanner to turn the rifle barrel. The small screw driver at the end of the large spanner is used for the removal of small screws, and the larger screw driver for the removal of the butt stock bolt and the forearm screws.

(13) *Wrench.*—Until a special tool is designed and issued, a  $\frac{7}{8}$  by 1 inch double head engineer's wrench may be used to remove the flash hider and bipod bearing from the muzzle end of the rifle barrel.

(14) *Stock rest.*—The stock rest is not used except when the Browning automatic rifle, caliber .30, M1918A2, is used as a substitute for the light machine gun in light machine-gun units.

SECTION VIII  
AMMUNITION

■ 39. **GENERAL.**—The information in this section pertaining to the several types of cartridges authorized for use in the Browning automatic rifle, caliber .30, M1918A2, includes a description of the cartridges, means of identification, care, use, and ballistic data.

■ 40. **CLASSIFICATION.**—Based upon use, the principal classifications of ammunition for this rifle are—

*Ball*, for use against personnel and light matériel targets.

*Tracer*, for observation of fire and incendiary purposes.

*Armor piercing*; for use against armored vehicles, concrete shelters, and similar targets.

*Dummy*, for training. (Cartridges are inert.)

■ 41. **LOT NUMBER.**—When ammunition is manufactured, an ammunition lot number, which becomes an essential part of the marking, is assigned in accordance with specifications. This lot number is marked on all packing containers and on the identification card inclosed in each packing box. It is required for all purposes of record, including grading and use, reports on condition, functioning, and accidents, in which the ammunition might be involved. Since it is impracticable to mark the ammunition lot number on each individual cartridge, every effort should be made to maintain the ammunition lot number with the cartridges once they are removed from their original packing. Cartridges which have been removed from the original packing and for which the ammunition lot number has been lost are placed in grade 3. It is therefore necessary when cartridges are removed from original packings that they be so marked that the ammunition lot number is preserved.

■ 42. **GRADE.**—Current grades of existing lots of small arms ammunition are established by the Chief of Ordnance and are published in Ordnance Field Service Bulletin No. 3-5.

No lot other than that of current grade appropriate for the weapon will be fired. *Grade 3 ammunition is unserviceable and will not be fired.*

■ 43. IDENTIFICATION.—*a. Markings.*—The contents of original boxes are readily identified by the markings on the box. Similar markings on the carton label identify the contents of each carton.

*b. Color bands.*—Color bands painted on the sides and ends of the packing boxes further identify the various types of ammunition. The following color bands for cartridges are used:

Armor piercing-----	Blue on yellow.
Ball-----	Red.
Tracer-----	Green on yellow.
Dummy-----	Green.

*c. Types and models.*—The following types and models of caliber .30 cartridges are authorized for use in this rifle:

- Ball, M2.
- Ball, M1.
- Armor piercing, M1.
- Armor piercing, M2.
- Armor piercing, M1922.
- Dummy, range, M1 or M1921.
- Tracer, M1.

When removed from their original packing containers, the cartridges may be identified except as to ammunition lot number and grade by physical characteristics described below.

(1) *Armor piercing.*—All models of caliber .30 armor piercing ammunition are distinguished by the nose of the bullet which is painted black for a distance of approximately  $\frac{1}{4}$  inch from the tip. The bullets have gilding metal jackets.

(2) *Ball.*—All models of caliber .30 ball ammunition, except the M1906, have bullets with gilding metal jackets. The jacket of the M1906 bullet is cupronickel which has a silvery appearance. The gilding metal jacket of the M2 bullet is tin coated and hence resembles the M1906 bullet in appearance. The gilding metal jacket of the M1 bullet is copper colored.

(3) *Tracer*.—Caliber .30 tracer ammunition may be identified by the nose of the bullet which is painted red for a distance of approximately  $\frac{1}{4}$  inch from the tip.

(4) *Dummy*.—The caliber .30 corrugated dummy cartridge may be identified by the corrugations formed in the cartridge case.

■ 44. CARE, HANDLING, AND PRESERVATION.—*a.* Small arms ammunition is not dangerous to handle. Care, however, must be exercised to keep the boxes from becoming broken or damaged. All broken boxes must be immediately repaired and all original markings transferred to the new parts of the box. The metal liner should be air tested and sealed if equipment for this work is available.

*b.* Ammunition boxes should not be opened until the ammunition is required for use. Ammunition removed from the airtight container, particularly in damp climates, is apt to corrode, thereby causing the ammunition to become unserviceable.

*c.* The ammunition should be protected from mud, sand, dirt, and water. If it gets wet or dirty wipe it off at once. Light corrosion, if it forms on cartridges, should be wiped off. However, cartridges should not be polished to make them look better or brighter.

*d.* No caliber .30 ammunition will be fired until it has been identified by ammunition lot number and grade.

*e.* Do not allow the ammunition to be exposed to the direct rays of the sun for any length of time. This is liable to affect seriously its firing qualities.

■ 45. STORAGE.—Whenever practicable small arms ammunition should be stored under cover. Should it be necessary to leave small arms ammunition in the open, it should be raised on dunnage at least 6 inches from the ground and the pile covered with a double thickness of paulin. Suitable trenches should be dug to prevent water from flowing under the pile.

■ 46. BALLISTIC DATA.—Approximate maximum ranges are as follows:

Cartridges, caliber .30:	<i>Yards</i>
Ball, M2-----	3,450
Ball, M1-----	5,500
Armor piercing, M1-----	4,000
Armor piercing, M2-----	4,500
Armor piercing, M1922-----	4,400
Tracer, M1-----	3,450

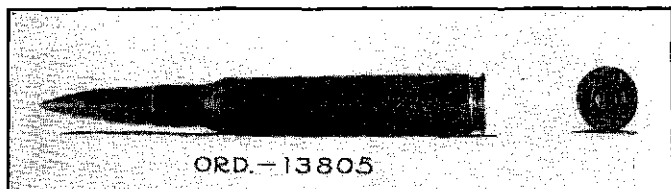

FIGURE 13.—Cartridge, ball, cal. .30, M2.



## CHAPTER 2

### MARKSMANSHIP, KNOWN DISTANCE TARGETS

	Paragraphs
SECTION I. General .....	47-49
II. Preparatory marksmanship training.....	50-72
III. Courses to be fired.....	73-75
IV. Range practice.....	76-85
V. Regulations governing record practice.....	86-116
VI. Targets and ranges.....	117-118

#### SECTION I

#### GENERAL

■ 47. OBJECT.—The object of this chapter is to provide a thorough and uniform method of training individuals to be good automatic rifle shots and of testing their proficiency in firing at known distance targets with the Browning automatic rifle, caliber .30, M1918A2, with bipod.

■ 48. FUNDAMENTALS.—To become a good automatic rifle shot the soldier must be trained in the following essentials of good shooting:

- a. Correct sighting and aiming.
- b. Correct positions.
- c. Correct trigger manipulation.
- d. Correct application of the fundamentals of automatic fire.
- e. Knowledge of proper sight adjustments.

■ 49. PHASES OF TRAINING.—a. Marksmanship training is divided into the following phases:

Preparatory marksmanship training.

Range practice.

b. No individual should be given range practice until he has had a thorough course in preparatory training.

c. The soldier should be proficient in mechanical training before he receives instruction in marksmanship training.

d. Every man who is to fire on the range will be put through the preparatory course regardless of previous qualifications.

## SECTION II

## PREPARATORY MARKSMANSHIP TRAINING

■ 50. GENERAL.—*a. Steps in training.*—The purpose of preparatory marksmanship training is to teach the soldier the essentials of good shooting and to develop fixed and correct shooting habits before he undertakes range practice. Preparatory marksmanship training is divided into six steps as follows:

- (1) Sighting and aiming exercises.
- (2) Position exercises.
- (3) Trigger manipulation exercises.
- (4) Automatic fire exercises.
- (5) Instruction in the effect of wind, sight changes, and use of the score book.
- (6) Examination of men before starting range practice.

*b. When taken up.*—Preparatory marksmanship will be taken up in the period stated in training programs and will precede range practice. Preparatory marksmanship training can be covered in 2 training days.

■ 51. EQUIPMENT.—*a. List.*—For each eight-man group—

- 2 sighting bars.
- 2 automatic rifles and rests.
- 2 3-inch sighting disks (fig. 14).
- 4 small aiming targets.
- 1 long range sighting disk.
- 2 small boxes.
- 1 target frame covered with blank paper for long range triangles.
- 1 score book for each man.
- 2 blank examination forms as shown in paragraph 72.
- 1 D target with curtain for each three groups.

*b. Preparation.*—(1) *Sighting bar.*—Construct the sighting bars from trim lumber and tin strip to the dimensions and design shown in figure 14. The sighting bars like all other equipment should be constructed so as to present a neat appearance. The tops of the sighting bars, their front and rear sights, and their eyepieces are painted black.

(2) *Automatic rifle and rest.*—An empty ammunition box or any similar box with notches cut in the ends to fit the

automatic rifle closely makes a good automatic rifle rest. The automatic rifle is placed in those notches with the trigger guard just outside one end. The sling is loosened and pulled to one side. The box is half filled with earth or sand to give it stability.

(3) *Sighting disks*.—Sighting disks are of two sizes. The disk to be used at a distance of 50 feet is shown in figure 14. The disk to be used at 200 yards is constructed by pasting the black silhouette of a standard D target on some stiff backing and attaching a 4-foot handle. The sighting disks have holes in their centers of a size sufficient to admit the point of a pencil.

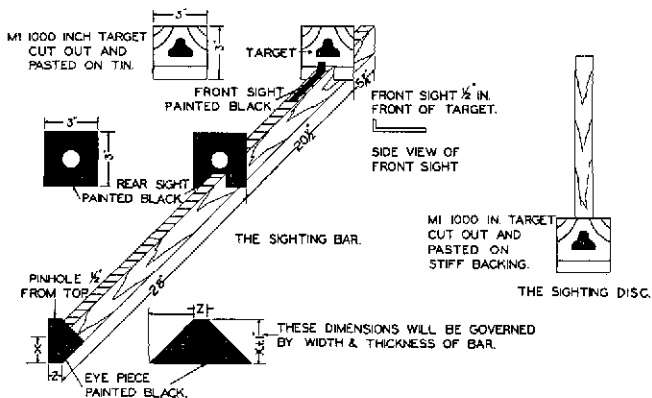

FIGURE 14.—Construction of sighting bar and sighting disk.

(4) *Blackening the sights*.—In all preparatory exercises involving aiming and in all range firing, both sights of the automatic rifle are blackened. Before blackening, the sights are cleaned and all traces of oil removed. The blackening is done by holding each sight for a few seconds in the point of a small flame which is of such a nature that a uniform coating of lampblack will be deposited on the metal. Materials commonly used for this purpose include carbide or kerosene lamps, candles, small pine sticks, and shoe paste.

■ 52. DUTIES OF LEADERS.—*a. Battalion commander*.—He requires the officers and noncommissioned officers to be familiar

with the prescribed methods of instruction and coaching; supervises the instruction within his battalion; and requires the companies to follow the preparatory exercises and methods of coaching carefully and in detail.

*b. Company commander.*—He requires the prescribed methods of instruction and coaching to be carried out carefully and in detail within his company; supervises and directs the platoon leaders.

*c. Platoon leader.*—He supervises and directs the squad leader in training his squad and examines the men in his platoon who are to fire the automatic rifle as outlined in paragraph 72. He keeps up a copy of the form showing the proficiency attained by each man (see form, par. 72).

*d. Sergeants.*—They assist in the instruction and perform any other duties as directed by the company and platoon commanders. They may assist the platoon leaders in keeping the forms referred to in *c* above.

*e. Squad leader.*—(1) He sees that each man in his squad is occupied in the designated preparatory training.

(2) He keeps up a separate copy of the form shown in paragraph 72 and promptly enters the grades made by his men as the work progresses. He has this form ready for the platoon leader's inspection at any time.

(3) He requires the coaches to correct errors.

■ 53. METHOD OF INSTRUCTION.—*a.* Men are grouped in pairs as coach and pupil and alternate in assisting and coaching each other.

*b.* Correct shooting habits are developed during the preparatory exercises, and to this end the careful execution of details is required. Training proceeds expeditiously to maintain interest. Care is taken to avoid holding the men in position until they become uncomfortable. Frequent short rests are given.

*c.* Officers and noncommissioned officer instructors will complete their own preparatory marksmanship training prior to that of their men in order that they may give their entire attention to the men whom they are to direct and instruct.

■ 54. DUTIES OF COACHES.—The successful conduct of the preparatory exercises largely depends upon the attention of

the coaches to their duties. Officers and noncommissioned officers are specifically charged with the supervision of coaches as well as of pupils. They will require the coaches to have their pupils execute all steps of the preparatory exercises correctly. The duties of a coach are specific and during the progress of the preparatory exercises include necessary correction of the pupil to see that the—

- a.* Sights are blackened.
- b.* Gun sling is properly adjusted.
- c.* Position is taken correctly.
- d.* Slack is taken up promptly.
- e.* Aim is carefully taken.
- f.* Breath is held during aiming (by watching the pupil's back).
- g.* Trigger is pressed properly.
- h.* Pupil calls the shot.

■ 55. FIRST SIGHTING AND AIMING EXERCISE: SIGHTING BAR.—The instructor or squad leader shows a sighting bar to his group and explains its use as follows, being careful to point out the various parts of the bar as he refers to them:

*a.* The front and rear sights on the sighting bar represent enlarged rifle sights.

*b.* The eyepiece on the sighting bar has no counterpart on the rifle. The eyepiece on the sighting bar is used as an aid to instruction because it enables the alinement of the sights to be demonstrated easily. The movable target on the sighting bar enables any alinement of the sight upon the silhouette to be shown.

*c.* He next explains the peep sight to his group and shows each man a correct sight alinement with the target removed. (See fig. 15.)

*d.* He next describes the correct aim. He explains that the top of the front sight is centered on the rear sight so as just to touch the bottom of the silhouette.

*e.* He explains that the eye should be focused on the sight picture, being sure that his front sight is distinct against the target, and he assures himself by questioning the pupils that each man understands what this means.

*f.* He adjusts the rear sight of the sighting bar and the movable target so as to illustrate the correct aim and has each man observe it by looking through the eyepiece.

*g.* He adjusts the rear sight and the movable target of the sighting bar so as to illustrate various small errors and has each man of the group detect and describe them.

*h.* Each man will then again be shown the bar with the correct aim illustrated.

*i.* Each man will then be required to adjust the sighting bar with the correct aim until he is proficient, using the coach and pupil method.



A CORRECT SIGHT  
WITH THE  
SIGHTING BAR.

FIGURE 15.—Correct sight with sighting bar.

■ 56. SECOND SIGHTING AND AIMING EXERCISE: ALINING SILHOUETTE AND SIGHTS.—An automatic rifle for each subgroup is placed in an automatic rifle rest and pointed at a blank sheet of paper mounted on a box at which a soldier with the small disk is stationed as marker. The coach or an instructor takes the prone position and without touching the automatic rifle looks through the sights. He directs the marker by voice or signal to move the small disk until the bottom of the sil-

houette is in correct allnement with the sights. He then calls "Hold," at which the marker will hold the small disk in position. The coach or instructor moves away from the automatic rifle and directs the pupil to look through the



①

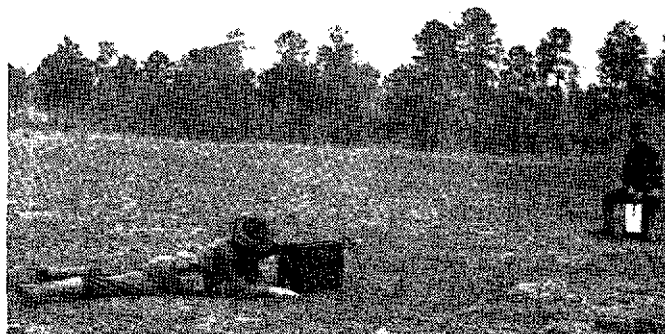

②

FIGURE 16.—Position for second sighting and aiming exercise.

sights in order to observe the correct aim. He then requires the pupil to execute the exercise for himself being careful to check the alinement which the pupil obtains.

■ 57. THIRD SIGHTING AND AIMING EXERCISE: MAKING SHOT GROUPS.—*a.* The object of this exercise is to teach uniform and correct aiming.

b. The exercise is conducted as follows: The automatic rifle with blackened sights is placed in an automatic rifle rest and pointed at a blank sheet of paper mounted on a box 50 feet distant. The pupil takes the prone position without touching the rifle or rests and looks through the sights. The pupil or coach directs the marker to move the small disk until the bottom of the silhouette is in correct alinement with the sights, and then calls "Hold." The instructor checks the alinement and then call "Mark." The marker immediately marks a dot on the paper with a sharp-pointed pencil inserted through the hole in the silhouette. The small disk is removed and the dot numbered. The pupil repeats this operation until three dots, numbered 1, 2, and 3, have been made. These dots outline the shot group and the pupil's name is written under it. The size and shape of the group will be discussed with the coach or instructor and the cause of error pointed out and corrected. This exercise is repeated until proficiency is attained. A good group of three marks can be covered by the eraser of an ordinary pencil.

c. A similar exercise is held during the period of preparatory marksmanship training at 200 yards with the 26-inch movable silhouette. Properly handled, the exercise helps greatly to sustain interest in the work and to teach correct aiming. At 200 yards a man should be able to make a shot group that can be covered with the small (3-inch) sighting disk.

d. Tracings are made of each man's 200-yard shot group. These tracings are marked with the men's names, turned over to the platoon leader for his information, and shown to the men with appropriate mention of errors to be corrected.

e. The shot group exercise may be continued during the remaining periods of preparatory marksmanship training to maintain interest and to secure the proficiency of men who require special instruction.

■ 58. POSITION EXERCISES.—*a. General.*—Instruction in position will include the use of the gun sling, holding the breath, and aiming in each position. Small targets are set up for each position to assist the aim.



*b. Scope of instruction.*—Detailed instruction will be given in each of the positions described in paragraphs 59 to 62, inclusive.

*c. General rules.*—(1) All positions are as carefully learned as the prone position, but the soldier is taught that the prone position with the bipod rest is the normal position, and that he must seek firing positions which will enable him to use this position.

(2) To assume any position except the prone position, first half face to the right and then assume the position.



FIGURE 17.—Position for third sighting and aiming exercise at long range.

(3) Upon assuming any position there is a point at which the rifle points naturally and without effort. If this point is not the center of the target, the whole body is shifted so as to bring the target into proper alinement.

(4) In all positions except the prone position with bipod rest, the bipod is in its locked position (i. e., legs of bipod locked in position along the barrel).

(5) The right hand grasps the small of the stock. The thumb may be around the small of the stock or on top of the stock.

(6) The left hand is not forced forward farther than is comfortable and convenient in the kneeling or sitting position. In the prone position it grasps the small of the stock. The left wrist is straight, and the rifle is placed in the crotch formed by the thumb and index finger and resting on the heel of the hand. The left elbow is as nearly under the rifle as it can be placed without strain.

(7) The trigger is pressed with the second joint of the index finger. The first joint may be used if necessary.

(8) The cheek firmly rests against the stock and is placed as far forward as possible without strain to bring the eye near the rear sight.

(9) Men are not permitted to shoot in the left-handed position.

(10) The hinged butt plate need not be used in any firing position except the prone position with the bipod rest.

*d. Gun sling.*—(1) The gun sling properly adjusted is of great assistance in shooting in all positions except prone with bipod rest in that it helps to steady the rifle. Each man is assisted by the instructor in securing the correct adjustment for his sling. In a firing position the sling is adjusted to give firm support without discomfort to the soldier. The gun sling is readjusted for drill purposes by means of the lower loop without changing the adjustment of the upper loop.

(2) There are two authorized adjustments—the loop sling and the hasty sling. The hasty sling is more rapidly adjusted than the loop sling, but it gives less support. The sling is not used on the arm when firing in the prone position with bipod rest.

(a) *Loop adjustment.*

1. Loosen the lower loop.
2. Insert the left arm through the upper loop from right to left so that the upper loop is near the shoulder and well above the biceps muscle.
3. Pull the keepers and hook close against the arm to keep the upper loop in place.
4. Move the left hand over the top of the sling and grasp the forearm of the rifle near the center so as to cause the sling to lie smoothly along the hand and wrist. The lower loop, not used in this

adjustment, should be so loose as to prevent any pull on it. Neither end will be removed from either swivel.

(b) *Hasty sling adjustment.*

1. Loosen the lower loop.
2. Grasp the forearm of the rifle near the center with the left hand and grasp the small of the stock with the right hand.
3. Throw the sling to the left and catch it above the elbow and high on the arm.
4. Remove the left hand from the rifle, pass the left hand under the sling, then over the sling, and regrasp the rifle with the left hand so as to cause the sling to lie along the hand and wrist. The sling may be given one-half turn to the left and then adjusted. This twisting causes the sling to lie smoothly along the hand and wrist.

*e. Holding the breath.*—The breath is held during aiming. To accomplish this, draw a little more air into the lungs than is used in an ordinary breath. Let out a little of this air and hold the rest naturally and without constraint.

*f. Aiming.*—The rifle is carefully aimed in each position.

*g. Canting the rifle.*—In all positions the rifle is squarely held, that is, not tipped or canted from a vertical plane passing through its long axis. It should be understood, however, that unless it is pronounced, this error in position will not materially affect the aim nor the strike of the burst.

*h. Procedure in conducting position exercises.*—Following explanations and demonstrations the instruction becomes individual by the coach and pupil method. Small silhouettes are used as aiming points. These silhouettes are placed at a range of 1,000 inches and at different heights so that in aiming from various positions the automatic rifle will be nearly horizontal, or standard known distance targets may be installed at distances used on the known distance range. The instructor may initiate an exercise by a command such as PRONE (SITTING, KNEELING) POSITION EXERCISES; WORK AT WILL. Each pupil, after seeing that his sights are blackened, adjusts his sling, takes position, takes up the slack, aims carefully, and holds his breath while aiming. As soon as his aim

becomes unsteady the exercise ceases. After a short rest the pupil repeats the exercise without further command. The trigger is not pressed in the position exercise. Exercises are conducted in all positions.

*i. Duties of the coach.*—In the position exercises the coach sees that the—

(1) Sights are blackened.

(2) Gun sling when used is properly adjusted, is tight enough to give support, and is high up on the arm.

(3) Proper position is taken.

(4) Slack is taken up properly.

(5) Pupil aims.

(6) Breath is held while aiming.

The coach checks the pupil's manner of holding his breath by watching his back.

■ 59. PRONE POSITION WITH BIPOD REST.—*a.* The automatic rifleman lies down in rear of the rifle, the line of the barrel extending through the center of his right shoulder and right hip bone. His legs are spread well apart. The toes may be dug in for additional bracing, but care should be taken to press evenly with both feet. The shoulder rest fits snugly on the back part of the shoulder, the butt pressed firmly into the hollow of the shoulder. The shoulders are on the same level. The right shoulder especially does not drop lower than the left shoulder. The elbows are out to the sides and on the same line to form a stable base of support for the rear of the weapon. The left hand grasps the weapon at the small of the stock, wrist straight, fingers uppermost, and the thumb extending under the stock. The right hand grasps the piece just ahead of the left hand, thumb over or on top of the stock, the index finger on the trigger, and the remaining fingers curled with a strong grip under and around the stock. Both hands hold the piece firmly against the shoulder. The left hand, in addition, exerts a downward pressure, holding the hinged butt plate down on the shoulder.

*b.* Some men, including left-handed men, may find that they are able to obtain more stability with the positions of the hands reversed, the right hand supporting the weapon and the left hand actuating the trigger.

c. When the firer is in the correct position, the gun is pointed at about the center of the target. Small adjustments to the exact point of the target which it is desired to hit can be made by moving the shoulders to the right and left or up and down. If the lateral movement is so great as to make it necessary to move the elbows, the entire body is shifted. Large vertical corrections are made by moving the elbows closer together or farther apart. Elevation adjustments may also be made by adjusting the bipod legs.

d. The soldier is trained to assume the correct position aided by a coach who will adjust the legs of the bipod for height.

e. Following this exercise the soldier will assume the correct position, adjusting the bipod without the aid of a coach. In



FIGURE 18.—Prone position with bipod rest.

doing this it is necessary to remove the weapon from the shoulder, slide around to the side, and make the adjustment. With training, the gunner is able to set the bipod correctly the first time.

f. *The sling is not used in this position.*

■ 60. SITTING POSITION.—The firer sits half faced to the right; feet well apart and well braced on the heels which are slightly dug into the ground; ankles relaxed; body leaning well forward from the hips with back straight; both arms resting inside the legs and well-supported; cheek resting firmly against the stock and placed as far forward as possible without straining; left hand as far forward as convenient and comfortable, wrist straight, rifle placed in the crotch formed by the thumb and index finger and resting on the heel of the

hand. In this position the feet may be slightly lower than the ground on which the firer sits. Sitting on a low sandbag is authorized. Necessary changes to adapt the position to the conformation of the man are authorized. Instruction in the sitting position is limited to that sufficient to acquaint the men with it, as the use of this position is regarded as exceptional.



FIGURE 19.—Sitting position.

■ 61. **KNEELING POSITION.**—The firer kneels half faced to the right on the right knee, sitting on the right heel, the left knee bent so that the lower left leg is vertical as viewed from the front; left arm well under the rifle and resting on the left knee with the point of the elbow beyond the kneecap; right elbow approximately at the height of the shoulder; cheek resting firmly against the stock and placed as far forward as possible without strain. Sitting on the side of the foot instead of the heel is authorized. The center of balance of the firer should be low and forward.

■ 62. **ASSAULT FIRE POSITION.**—In this position the automatic rifle is held with the butt under the right armpit, clasped



FIGURE 20.—Kneeling position.



FIGURE 21.—Assault fire position.

firmly between the body and the upper portion of the arm, the sling over the left shoulder.

■ 63. SIGHT SETTING EXERCISES.—*a.* The purpose of the sight setting exercises is to teach accurate and rapid sight setting.

*b.* The instructor explains the difference between the open sight (battle sight) and the peep sight. He explains that the movable slide on the rear sight is set at the desired range graduation so that the gun will have proper elevation when it is aimed. He explains the wind gage on the rear sight and that the front sight may be moved to the right or left in zeroing the rifle when necessary. The instructor then has a soldier take his place at the automatic rifle in the prone position and demonstrate the exercise as follows:

(1) The instructor announces the range, for example, "Range 800."

(2) The automatic rifleman raises the sight leaf, sets the sight with the correct setting, and assumes the correct firing position.

(3) The instructor checks the sight setting.

*c.* Each group then performs the exercise explained above under the supervision of the group instructor until all are proficient in accurate and rapid sight setting.

■ 64. SIGHT SETTING AND AIMING EXERCISE.—*a.* The purpose of the sight setting and aiming exercise is to develop accuracy and speed in setting the sights and aiming the rifle.

*b.* The target shown in figure 23 is set up 1,000 inches from the rifle; the automatic rifleman is in the prone position with bipod adjusted.

*c.* The instructor demonstrates the exercise as follows:

(1) The instructor announces the range and designates the target by giving a fire order such as "Range 300, figure No. 1." After giving the first element of the command, the instructor pauses a sufficient length of time to permit the automatic rifleman to repeat it. The automatic rifleman then raises the sight leaf and sets the sight. While he is setting the sight the instructor announces the target. The automatic rifleman repeats this second element of the command, and upon completing the sight setting moves his body and the



rifle until the sights are accurately alined upon the designated aiming point. He then calls "Up."

(2) The instructor then checks the sight setting and aiming, pointing out the errors if any.

*d.* The men then go through the exercise under the supervision of the group instructors until they become proficient in setting the sight and aiming the gun on a designated aiming point within a time limit of 10 seconds. Each exercise will start with the sight leaf down and the slide set at 500 yards.

■ 65. TRIGGER MANIPULATION EXERCISE.—*a. General.*—The trigger is pressed in such a way as to fire the first shot without affecting the aim. The aim is held as steadily as possible, and the trigger is pressed promptly by a constantly increasing pressure applied to the rear by the independent action of the forefinger only until the bolt is released. The release of the trigger is dependent upon the length of burst desired. In firing bursts at the slow cyclic rate, the trigger is pressed rapidly to its full extent to the rear or a burst at the normal cyclic rate will ensue during the time the sear nose is depressed and the rear of the sear release stop lever is in its upper position. (See par. 23*n*.) This method of pressing the trigger is carried out in all preparatory exercises or the value of the practice is lost.

*b. Trigger manipulation.*—Trigger manipulation exercises are carried out in the preparatory exercises regardless of the fact that the men undergoing instruction may have just completed firing with the U. S. rifle, caliber .30, M1903, or the U. S. rifle, caliber .30, M1. The forward movement of the bolt when the trigger is pressed is confusing to many men and causes them to allow the alinement of the sights to become incorrect. The rifle is held steady and in perfect alinement during this forward movement.

*c. Taking up the trigger slack.*—The first movement of the trigger which takes place when light pressure is applied is called "taking up the slack." It is part of the position exercise, because this play must be taken up by the finger as soon as the correct position is assumed and before careful aiming is begun. The entire amount of slack in trigger is taken up by one positive movement of the finger.

*d. Calling the shot.*—The pupil always notices where the sights are pointed at the instant the rifle is fired, or when the bolt reaches its forward position in simulated fire, and calls out at once where he thinks the bullet will hit. In automatic fire he calls the first shot.

*e. Scope of instruction.*—(1) The pupil is first taught trigger manipulation in the prone position with bipod rest. In this position he can hold steadily while he presses the trigger. After proficiency is obtained in the prone position with the bipod rest, trigger manipulation is practiced in the sitting and kneeling positions.

(2) Trigger manipulation for firing bursts and for firing single shots will be taught. The Browning automatic rifle, caliber .30, M1918A2, is not capable of semiautomatic fire. However, by having the rifle set for the slow cyclic rate, single shots may be fired by releasing the pressure on the trigger immediately upon the release of the bolt for its forward movement. This rapid trigger release is taught during instruction in trigger manipulation.

(3) In all exercises where fire is simulated, men will carry out the correct principles of aiming, pressing the trigger, and calling the shot.

■ 66. AUTOMATIC FIRE EXERCISE.—*a.* Automatic fire exercises enable the soldier to gain dexterity in the manipulation of the automatic rifle. Efficient manipulation is an important factor in automatic rifle firing.

*b.* Automatic fire exercises are held at 1,000 inches on the U. S. rifle, caliber .30, M1, target. The exercises include observance of the fundamentals of sighting, positions, and trigger manipulation as taught in the preceding exercises.

*c.* Automatic fire exercises are conducted as follows:

(1) The instructor announces the range as "Range, 300"; designates the target and number of rounds as "Figures 5 to 6, 16 rounds."

(2) The automatic rifleman sets his sights at the announced range, aims at figure No. 5, and simulates firing 16 rounds across to the right. He simulates firing 2 rounds, traverses right to the next figure, and simulates firing 2 more rounds, and so on until he has completed the simulated

firing of 16 rounds. He checks his aim each time on the figure on which he is firing.

d. The duties of the coach in automatic fire exercises are to insure that—

(1) The sights are set for the ranges designated and are blackened.

(2) The correct position is taken.

(3) The slack is taken up promptly.

(4) The breath is held while aiming.

(5) The trigger is pressed properly.

(6) Each time the pupil completes the simulated firing of two rounds on a figure he promptly traverses right to the next figure.

(7) The pupil checks his aim each time on the figure on which he is firing.

(8) The eye is kept on the target, the elbows kept in place, and the butt of the rifle kept to the shoulder.

(9) The automatic rifle is reloaded quickly and without fumbling.

■ 67. EXERCISES IN REPLACING MAGAZINES.—a. Exercises should be conducted in which the soldier replaces his own magazines. In these exercises the following points should be stressed:

(1) When the last shot in the magazine is fired, the bolt being in the rearward position and the rifle held horizontally, the automatic rifleman pushes the magazine release with his right thumb and the magazine falls out of its own weight.

(2) Full magazines are so placed in the belt that when grasped and carried forward by the right hand the long portion will be to the rear. Thus they may be readily inserted in the magazine opening in the receiver.

(3) Empty magazines are picked up and placed in the belt.

(4) Each soldier changes his own magazines. He must be able to do it in 2 to 4 seconds while in any position. He tests all magazines before loading them to see that they will fall out of their own weight when empty.

b. These operations are taught as a drill in which the following points should be carefully observed:

(1) Magazines are placed in the magazine belt so that when grasped and carried forward by the right hand the long portion will be to the rear.



① Pressing magazine release with right thumb.



② Reaching for new magazine.



③ Inserting new magazine.

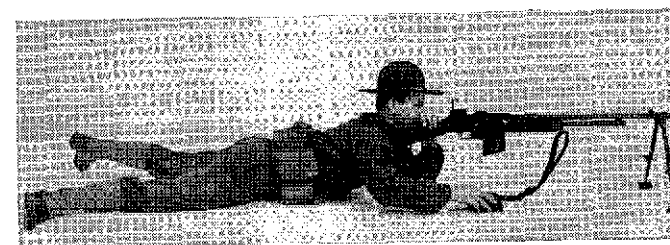

④ Reaching for old magazine.



⑤ Replacing old magazine in belt.

FIGURE 22.—Drill in replacing magazine.

(2) The operating handle is drawn to the rear after the last shot if the bolt is in the forward position.

(3) Magazines are dropped out after the last shot.

(4) All magazines to be used fall out of their own weight when empty.

(5) The new magazine is drawn from the belt and placed in the receiver with one rapid, smooth movement.

(6) Empty magazines are picked up and placed in the belt. In known distance range firing they will be placed in the belt at the conclusion of the firing of the exercise.

■ 68. WINDAGE.—*a. Direction of wind.*—The horizontal clock system is used to describe the direction of the wind. In this system the firer is assumed to be at the center of a clock and the target at 12 o'clock. A 3 o'clock wind then blows directly from the right, a 9 o'clock wind directly from the left, and other winds from their corresponding directions on the clock. Right windage is taken to counteract the effects of winds coming from the right of the clock and left windage to counteract those coming from the left. The amount of windage to allow for the first shot is shown by the windage diagram in *W. D., A. G. O. Form No. 82 (Individual Score Book)* by *substituting* four thirds of a point of windage for each point of windage there indicated. After the first shot is marked, the necessary correction in windage to bring shots into the silhouette is found by reference to the target on page 16 of the score book and applying the windage rule.

b. *Windage rule.*—One click of the windage knob (or one point of windage) moves the strike of the bullet 3 inches on the target for each 100 yards of range. Right windage moves the strike of the bullet to the right, and left windage moves it to the left.

■ 69. **ELEVATION.**—*a. Range.*—Changes in elevation are made on the sight of the rifle for the primary purpose of adjusting for range.

b. *Effect of light.*—Light has an effect upon aim, generally causing men to aim slightly lower in a poor light than in a good one. Slight corrections in elevation are therefore necessary at times for this reason.

c. *Elevation rule.*—One click of the elevating knob moves the strike of the bullet 3 inches on the target for each 100 yards of range.

■ 70. **EXPLANATION OF ZERO.**—*a.* An explanation of the zero of the Browning automatic rifle, caliber .30, M1918A2, should be included in the instruction in sight setting. The zero of this rifle for any range under normal weather conditions is that sight setting of elevation and windage which will center the shot group in the target. It may vary for the same rifle with different men on account of differences in eyesight. Each man should understand this explanation of the zero of a rifle, and that he will be required to keep a record of the zeroes for his own rifle for the various ranges in his score book.

b. Instructions for zeroing the rifle on the 1,000-inch range and on the known distance range are given in section IV.

■ 71. **SCORE BOOK.**—The use by the soldier of a score book to keep a personal record of the results and conditions of his firing throughout the period of range practice is as necessary with the automatic rifle as with the service rifle. W. D., A. G. O. Form No. 82 is used for the automatic rifle.

■ 72. **EXAMINATION.**—*a.* Men will be examined prior to proceeding to range practice to determine their proficiency in the subjects covered in chapter 1 and in this section.

b. This examination consists of questions as indicated below which are designed to bring out the soldier's knowledge of the weapon and of demonstrations on his part of his practical ability in the subjects which have been covered. The questions are answered by the soldier in his own words.

Q. What is the name of the automatic rifle?—A. The Browning automatic rifle, caliber .30, M1918A2.

Q. What type weapon is it?—A. Shoulder weapon, gas operated, air cooled, magazine fed.

Q. How is the barrel cooled?—A. There is no special cooling device. The barrel is merely exposed to the air.

Q. What is meant by gas operated?—A. All of the functions of the automatic rifle, such as extraction and feeding, are accomplished by a small portion of gas escaping through a port in the barrel and impinging on a piston.

Q. How is the examination on disassembling and assembling of the automatic rifle conducted?—A. (Man being examined disassembles and assembles the rifle, naming parts.)

Q. How many rounds are carried in the magazine?—A. Twenty.

Q. What care must be taken of the magazines?—A. They will be kept cleaned and well oiled. They will not be dented or bent.

Q. How are the magazines filled?—A. By placing the magazine filler over the magazine and loading four clips in the same manner as in the service rifle.

Q. How are the magazines loaded into the rifle?—A. (Man being examined loads rifle and releases magazine.)

Q. Why should the accessory and spare parts kit be carried?—A. Because it contains equipment which is necessary to keep the rifle in action.

Q. How is the firing pin removed without disassembling the rifle?—A. (Man being examined shows how it is done.)

Q. How is the extractor removed without disassembling the rifle?—A. (Man being examined shows how it is done.)

Q. What is the first thing to do in case of any stoppage?—A. Tap the magazine, pull back and push forward the operating handle, aim, and try to fire again.

Q. What is the next thing to do in case you have tried to fire again and the stoppage recurs?—A. Pull back the operating handle slowly until it strikes the hammer pin and see what is the position of the stoppage; drop out the magazine; then apply immediate action.

Q. What are the three stoppages in the first position?—A. Failure to feed, failure to fire, and insufficient gas.

Q. What things may cause failure to fire in the first position?—A. Defective ammunition, broken firing pin, weak recoil spring, and too much friction.

Q. What usually causes failure to feed?—A. Magazine trouble.

Q. How can you tell when the rifle is not getting enough gas?—A. The rifle will fire but the bolt will not go to the rear.

Q. If your rifle is giving you trouble, due to failure to extract, what is probably the trouble?—A. The chamber of the rifle has not been properly cleaned.

Q. What is this (drawing a circle on the ground or on paper)?—A. A circle.

Q. Where is the center of it?—A. Here (pointing to the center).

Q. Suppose that circle represents a peep sight through which you are looking and that you are told to bring the top of the front sight to the center of it; where would the top of the front sight be?—A. Here (pointing to the center of the circle).

Q. Make a mark in the circle to represent the front sight. Make a small silhouette to represent the silhouette. Is the silhouette in the center of the peep sight?—A. No; the bottom edge of it is in the center.

Q. Why?—A. Because the top of the front sight is in the center and just touches the bottom edge of the silhouette.

Q. Should the front sight be held up into the bottom of the silhouette?—A. No; it just touches the bottom edge of the silhouette, so that all of the silhouette can still be clearly seen.



Q. What is this (indicating sighting bar)?—A. Sighting bar.

Q. What is it for?—A. To teach me how to aim.

Q. Why is it better than an automatic rifle for this purpose?—A. Because the sights on it are much larger, and slight errors can be more easily seen and pointed out.

Q. What does this represent?—A. The front sight.

Q. And this?—A. The rear sight.

Q. What is this?—A. The eyepiece.

Q. What is the eyepiece for?—A. To cause me to place my eye in such a position as to see the sights in the same alignment as that set by the coach.

Q. Is there any eyepiece on the automatic rifle?—A. No; I learn by the sighting bar how the sights look when properly aligned, and I must hold my head so as to see the sights the same way when aiming an automatic rifle.

Q. How do you hold your head steadily in this position when aiming an automatic rifle?—A. By resting my cheek firmly against the side of the stock.

Q. Where do you focus your eye when aiming an automatic rifle?—A. On the silhouette.

Q. Tell me what is wrong with these sights. (The instructor now adjusts the sights of the bar, making various slight errors; first, to show the correct and incorrect adjustments of the sights, and then, with the sights properly adjusted, he sights on the small silhouette to demonstrate correct and incorrect adjustments, requiring the men to point out any errors.) Now take this sighting bar and adjust the sights properly. (Verified by the instructor.) Now that the sights are properly adjusted, have the small silhouette moved until the sights are properly aimed at it. How do you breathe while aiming?—A. After I get my sights lined up on the silhouette, I draw in a little more than an ordinary breath and let out a little, and hold the remainder while aiming and pressing the trigger.

Q. Take the prone position, aim, and simulate firing a shot at that mark. (The instructor must assure himself that the man knows how to hold his breath properly while aiming. Many men have great difficulty in learning to do this

correctly.) What is the best position from which to fire the automatic rifle?—A. Because of its weight it should be fired from the prone position with bipod rest.

Q. Why is the sling used with the automatic rifle in the sitting or kneeling position?—A. To assist the firer in holding steadily.

Q. I will take the automatic rifle and assume the kneeling, sitting, and prone positions, and you will tell me whether the position is correct or incorrect in each case. (The gun sling is adjusted for the sitting and kneeling positions in all these tests.) Take this automatic rifle and show me your kneeling, sitting, and prone positions. How do you press the trigger in firing bursts at the slow cyclic rate?—A. I press the trigger rapidly to its full extent to the rear with a constantly increasing pressure, applied by the independent action of the forefinger, and hold the trigger to its full extent to the rear for the length of burst desired.

Q. What do you know while you are pressing the trigger?—A. I know that the sights are lined upon the silhouette.

Q. When firing bursts are all shots aimed shots?—A. No. The first shot of each burst is an aimed shot, although it is not possible to aim as carefully as in firing single shots. The correct position is so steady that after each burst the gun will return to the target and it is necessary only to glance along the sights to see that they are properly aligned.

Q. Is it necessary to take a long time to press the trigger?—A. No. The necessary rapidity is developed by practice in the trigger manipulation exercise.

Q. How do you press the trigger in firing single shots?—A. I press it the same way as in firing bursts but I release the pressure on the trigger immediately upon the release of the bolt to its forward position.

Q. In firing several bursts how do you gain time so as not to be compelled to hurry in aiming?—A. I gain time by changing magazines rapidly and by keeping my eye on the target while firing.

Q. How does keeping your eye on the target help you to gain time?—A. A man who looks away from his target loses time in finding his own target again.

Q. Now show me how you load a magazine into the receiver.—A. (Soldier demonstrates.)

Q. How are the magazines changed while firing in the prone position?—A. (Soldier demonstrates.)

Q. Is it important to get into the correct position before beginning to shoot?—A. Yes; even though it takes more time, I should always get into the correct position before beginning to shoot.

Q. What is meant by calling the shot?—A. To say where you think the bullet hit in firing single shots and where the first round hit in firing bursts.

Q. How can you do this?—A. By noticing exactly where the sights point when the single shot or the first round is fired.

Q. What is this?—A. A score book.

Q. What are these lines for (indicating the vertical lines on the model target)?—A. To show the amount of change in windage necessary to bring the shot to the middle line.

Q. If a shot hits here (indicating), what change in your sight would you make to bring the next shot to the center of the silhouette?—A. (Soldier explains.)

Q. What effect does moving your rear sight have on the shot?—A. It moves it in the same direction as the rear sight moves.

Q. If you want to make a shot hit higher, what do you do?—A. I increase my elevation.

Q. If you want to make your shots hit more to the right, what do you do?—A. I move my rear sight to the right.

Q. If you move your rear sight one point or 1 click of windage how much will it move the point struck by the bullet?—A. Three inches for each 100 yards of range.

Q. Explain what you mean by that. I will place this spotter on this target (full size D target) to represent a shot properly fired by you at 500 yards with zero windage and sight set at 500 yards. Take your rifle and move your sight to bring the next shot to the center of the silhouette. (Instructor now tests in various ways the man's ability to make proper sight corrections.) What are the three principal uses of the score book?—A. To show me where my shot group

is located, to indicate how much change in the sight is necessary, to move a shot or group of shots to the center of the target, and to make a record of the sight settings of my rifle for the different ranges under various weather conditions so that I will know where to set my sight when starting to shoot at each range under different weather conditions.

Q. Tell me what effect different light and weather conditions have on a man's shooting.

Q. In firing at ranges up to and including 600 yards, what is the only weather condition for which you make sight corrections?—A. Wind.

Q. What three things do you do in cleaning a rifle bore after it has been fired?—A. I first remove the powder fouling from the bore. I then dry the bore thoroughly of the liquid used in removing the fouling. After this is done I oil the bore to protect it from rust.

Q. How do you remove the powder fouling from the bore?—A. By swabbing it thoroughly two or more times with cleaning patches saturated with a hot water and sal soda or issue soap solution.

Q. How do you dry the bore?—A. By running clean patches through the bore until it is thoroughly dry.

Q. How do you protect the bore from rust?—A. By swabbing it thoroughly with a cleaning patch saturated with oil.

Q. In what way does cleaning the automatic rifle after firing differ from cleaning the service rifle?—A. It is necessary to clean the piston, gas cylinder, chamber, and magazines, as well as the bore.

Q. How should the metal parts of the rifle be oiled?—A. The rifle should be oiled by wiping a thin film of oil over all metal parts after cleaning.

Q. Why cannot the barrel be removed and cleaned from the breech?—A. It is very difficult to replace the barrel as tightly as it should be, and as soon as the barrel works loose the rifle will develop head space trouble.

c. The form shown below will be completed for each individual who is to fire as an essential part of this examination:

## STATE OF INSTRUCTION

Name	Disassembling and assembling	Care and cleaning	Knowledge of functioning	Operation	Immediate action and stoppages	Sighting bar (first sighting and aiming exercise)	Aligning sights (second sighting and aiming exercise)	Making shot groups (third sighting and aiming exercise)	Prono position (with bipod rest)	Sitting position	Kneeling position	Assault fire position	Sight setting and aiming exercise	Trigger manipulation exercise	Automatic fire exercise	Replacing magazines	Taking windage	Taking elevation	Understanding of the zero of a rifle	Use of the score book	Final grade
Brown	.....	.....	.....	.....	.....	.....	.....	.....	.....	.....	.....	.....	.....	.....	.....	.....	.....	.....	.....	.....	.....
Jones	.....	.....	.....	.....	.....	.....	.....	.....	.....	.....	.....	.....	.....	.....	.....	.....	.....	.....	.....	.....	.....
Smith	.....	.....	.....	.....	.....	.....	.....	.....	.....	.....	.....	.....	.....	.....	.....	.....	.....	.....	.....	.....	.....
Knox	.....	.....	.....	.....	.....	.....	.....	.....	.....	.....	.....	.....	.....	.....	.....	.....	.....	.....	.....	.....	.....

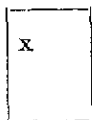

Fair

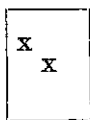

Good



Very good

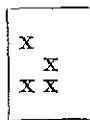

Excellent



Excellent and has instructional ability

## SECTION III

## COURSES TO BE FIRED

■ 73. SCOPE AND OBJECT OF RANGE PRACTICE.—a. Range practice is divided into two phases:

1,000-inch range practice.

Known distance range practice.

b. In all range firing, the automatic rifle will be set for the slow cyclic rate.

c. Practice on the 1,000-inch range is included in all marksmanship courses to conserve time, ammunition, and troop labor during the range season. The 1,000-inch range pro-

vides a convenient, short distance range whereon the soldier can receive training with service ammunition in the fundamentals of automatic rifle marksmanship. Firing on the 1,000-inch range will be included in instruction practice for every individual firing a qualification course. The amount of such firing within the limits set forth in the tables will be determined by the company or higher commander. In general, recruits will require more of this type of firing in their instruction than previously qualified men.

■ 74. SEQUENCE OF FIRING.—The instruction practice outlined for each course is intended to serve as a guide. Variations may be made in the sequence prescribed within instruction practice to take advantage of time, weather, and range facilities. Variations may be made in the sequence prescribed within record practice for the same reasons. In no case will an individual's record practice in a course be interspersed with his instruction practice.

■ 75. MARKSMANSHIP COURSES.—One of the following courses will be fired by each automatic rifleman. The conduct and rules governing these courses are covered in sections IV and V. The particular course to be fired will be designated by higher authority in accordance with the provisions of AR 775-10. In all exercises which require single shots, the magazine will be loaded with the five rounds necessary for the complete score. (See also par. 95a(3).)

a. Course A.—(1) 1,000-inch range.—(a) To zero the rifle.

TABLE I

Range (inches)	Time	Shots	Target (1,000-inch)	Position	Remarks
1,000	No limit	5	No. 1	Prone, bipod rest	Single shot.
1,000	do	5	No. 2	Kneeling	Loop or hasty sling. Single shot.

*(b) Instruction practice.*

TABLE II

Range (inches)	Time (seconds)	Shots	Target (1,000 inch)	Position	Remarks
1,000	No limit	5	No. 1	Prone, bipod rest.	Single shot.
1,000	do	5	No. 2	Kneeling	Loop or hasty sling. Single shot.
1,000	25	20	No. 3 and No. 4.	Prone, bipod rest.	1 magazine, 20 rounds, in short bursts; 10 rounds on each figure.
1,000	115	40	No. 5 to No. 6.	do	Search and traverse 8 magazines of 5 rounds, each in 5 round bursts.
1,000	85	40	No. 7 to No. 8.	do	Search and traverse 4 magazines of 10 rounds, each in 5-round bursts.

*(2) Known distance range.—(a) Instruction practice.*

TABLE III

Range (yards)	Time	Shots	Target	Position	Remarks
200	No limit	5	Rifle D	Prone, bipod rest.	Single shot.
200	do	5	do	Kneeling	Loop or hasty sling. Single shot.
300	do	5	do	Prone, bipod rest.	Single shot.
500	do	5	do	do	Do.

TABLE IV

Range (yards)	Time	Shots	Target	Position	Remarks
200.....	No limit	5	Rifle D.....	Kneeling.....	Loop or hasty sling. Single shot.
200.....	do.....	5	do.....	Prone, bipod rest.	1 magazine, 5 rounds, 5-round burst.
300.....	do.....	5	do.....	do.....	1 magazine, 5 rounds, 5-round burst.
500.....	do.....	5	do.....	do.....	Single shot.
500.....	do.....	10	do.....	do.....	1 magazine, 10 rounds, in short bursts.

TABLE V

Range (yards)	Time (seconds)	Shots	Target	Position	Remarks
200.....	No limit	5	Rifle D.....	Kneeling.....	Loop or hasty sling. Single shot.
200.....	30.....	15	do.....	Prone, bipod rest.	3 magazines, 5 rounds each, in 5-round bursts.
300.....	30.....	15	do.....	do.....	3 magazines, 5 rounds each, in 5-round bursts.
500.....	No limit	5	do.....	do.....	Single shot.
500.....	25.....	10	do.....	do.....	1 magazine, 10 rounds, in short bursts.

TABLE VI

Range (yards)	Time (seconds)	Shots	Target	Position	Remarks
200.....	30	15	Rifle D.....	Prone, bipod rest.	3 magazines, 5 rounds each, in 5-round bursts.
300.....	30	15	do.....	do.....	3 magazines, 5 rounds each, in 5-round bursts.
500.....	25	10	do.....	do.....	1 magazine, 10 rounds, in short bursts.



*(b) Record practice.*

TABLE VII

Range (yards)	Time (seconds)	Shots	Target	Position	Remarks
200.....	No limit.	5	Rifle D.....	Prone, bipod rest.	Single shot.
200.....	30.....	15	do.....	do.....	3 magazines, 5 rounds each, in 5-round bursts.
300.....	30.....	15	do.....	do.....	3 magazines, 5 rounds each, in 5-round bursts.
500.....	No limit.	5	do.....	do.....	Single shot.
500.....	25.....	10	do.....	do.....	1 magazine, 10 rounds, in short bursts.

- b. Course B.—(1) 1,000-inch range.—Fire tables I and II.  
 (2) Known distance range.—(a) Instruction practice.*

TABLE VIII

Range (yards)	Time	Shots	Target	Position	Remarks
200.....	No limit.	5	Rifle D.....	Prone, bipod rest.	Single shot.
200.....	do.....	5	do.....	Kneeling.....	Loop or hasty sling. Single shot.
300.....	do.....	5	do.....	Prone, bipod rest.	Single shot.

TABLE IX

Range (yards)	Time	Shots	Target	Position	Remarks
200.....	No limit.	5	Rifle D.....	Kneeling.....	Loop or hasty sling. Single shot.
200.....	do.....	5	do.....	Prone, bipod rest.	1 magazine, 5 rounds, 5-round burst.
300.....	do.....	5	do.....	do.....	Do.

TABLE X

Range (yards)	Time (seconds)	Shots	Target	Position	Remarks
200.....	No limit.	5	Rifle D.....	Kneeling.....	Loop or hasty sling. Single shot.
200.....	30.....	15	do.....	Prone, bipod rest.	3 magazines, 5 rounds each, in 5-round bursts.
300.....	30.....	15	do.....	do.....	Do.

TABLE XI

Range (yards)	Time (seconds)	Shots	Target	Position	Remarks
200.....	30.....	15	Rifle D.....	Prone, bipod rest.	3 magazines, 5 rounds each, in 5-round bursts.
300.....	30.....	10	do.....	do.....	Do.

(b) *Record practice.*

TABLE XII

Range (yards)	Time (seconds)	Shots	Target	Position	Remarks
200.....	No limit.	5	Rifle D.....	Prone, bipod rest.	Single shot.
200.....	30.....	15	do.....	do.....	3 magazines, 5 rounds each, in 5-round bursts.
300.....	30.....	15	do.....	do.....	Do.

- c. *Course C.*—(1) *1,000-inch range.*—Fire tables I and II.  
 (2) *Known distance range.*—(a) *Instruction practice.*

TABLE XIII

Range (yards)	Time	Shots	Target	Position	Remarks
200.....	No limit.	5	Rifle D.....	Prone, bipod rest.	Single shot.
200.....	do.....	5	do.....	Kneeling.....	Loop or hasty sling. Single shot.

TABLE XIV

Range (yards)	Time	Shots	Target	Position	Remarks
200.....	No limit.	5	Rifle D.....	Kneeling.....	Loop or hasty sling. Single shot.
200.....	do.....	5	do.....	Prone, bipod rest.	1 magazine, 5 rounds, 5-round burst.

TABLE XV

Range (yards)	Time (seconds)	Shots	Target	Position	Remarks
200.....	No limit.	5	Rifle D.....	Kneeling.....	Loop or hasty sling. Single shot.
200.....	30.....	15	do.....	Prone, bipod rest.	3 magazines, 5 rounds each, in 5-round bursts.

TABLE XVI

Range (yards)	Time (seconds)	Shots	Target	Position	Remarks
200.....	30.....	15	Rifle D.....	Prone, bipod rest.	3 magazines, 5 rounds each, in 5-round bursts.

(b) *Record practice.*

TABLE XVII

Range (yards)	Time (seconds)	Shots	Target	Position	Remarks
200.....	No limit..	5	Rifle D.....	Prone, bipod rest.	Single shot.
200.....	do.....	5	do.....	Kneeling.....	Loop or hasty sling. Single shot.
200.....	65.....	30	do.....	Prone, bipod rest.	6 magazines, 5 rounds each, in 5-round bursts.

*d. Course D—1,000-inch range.*—(1) *Instruction practice.*—Fire tables I and II and repeat table II.

(2) *Record practice.*—Fire table II.

## SECTION IV

## RANGE PRACTICE

■ 76. GENERAL.—*a. Training programs and schedules.*—Training programs and schedules will provide a period for range practice.

*b. Range practice.*—Range practice includes both 1,000-inch firing and known distance firing.

*c. Officers' range practice.*—The officers of an organization should be enabled to complete their own range practice in advance of their men whenever practicable in order that their entire attention may be given to their instructional duties.

*d. Uniform.*—The uniform to be worn during instruction practice and record practice will be prescribed by the commanding officer. The automatic rifleman's belt will be worn during instruction practice and record practice.

*e. Use of pads.*—The use of elbow pads is recommended. The use of shoulder pads is unnecessary but is permitted.

■ 77. ORGANIZATION.—The officers, noncommissioned officers, and coaches of the units on the range will perform duties generally similar to those prescribed for them in preparatory marksmanship instruction. (See sec. II.)

*a. Officer in charge of firing.*—An officer in charge of firing will be designated by the responsible commander. This officer or his deputy will be present during all firing and will be in charge of the practice and safety precautions on the range.

*b. Range officer.*—A range officer with such commissioned and enlisted assistants as are necessary will be appointed by the post or station commander well in advance of range practice. At large camps or stations where the coordination of range practice for different organizations is involved, he may function as the direct representative of the camp or station commander. In other cases he is responsible to the officer in charge of firing and in all cases he cooperates closely with him. The range officer will make timely estimates for material and labor to place the range in proper condition for range practice, and will supervise and direct all necessary repairs to shelters, butts, targets, firing points, and telephone lines. He exercises direct supervision over the practical operation of the rifle range during the practice season. He regulates the distribution of ranges and targets and in general assists the officer in charge of firing by using the means necessary to secure efficient and accurate service from the working force of the range. He provides safe conditions for the markers and any visitors. Whenever necessary he provides range guards and instructs them in the methods to be used for the protection of life and property in the danger area.

*c. Unit range officers.*—During the operation of any range by a unit the commanding officer thereof may detail an officer as unit range officer. The unit range officer will be responsible to the commanding officer of the organization to which the range is assigned for its efficient operation.

*d. Pit detail.*—An officer or noncommissioned officer with such assistants as may be necessary will be detailed in charge of arrangements in the pit. He will be responsible to the officer in charge of firing for the discipline, efficiency, and safety of all pit details. He sees that all of the target equipment is kept in serviceable condition; that the desired targets are ready for firing at the appointed time; and that all target details are provided with the proper flags, marking disks, paste, pasters, and spotters.

■ 78. USE OF DUMMY CARTRIDGES.—The corrugated type of dummy cartridges may be used in range practice. When ammunition must be conserved, a proportion of the corrugated type dummies may be included in magazines with live ammunition. The use of any other type of range dummies is prohibited.

■ 79. FIRING POINTS.—All firing points should have firm soil. Loose loam or sand on the firing point has an adverse effect on accuracy.

■ 80. COACHING.—*a. General.*—(1) During instruction practice, each man on the firing line will have a coach to watch him and to help him correct his errors. An average soldier who has been properly instructed in the preparatory work or who has been given instruction in coaching methods can be used with good results and is used when more experienced coaches are not available.

(2) It is good practice to have experienced coaches in charge of one or more targets, usually on a flank, to which pupils are sent for special coaching if required.

(3) Great patience should be exercised by the coach so as not to excite or confuse the firer. Everything is done to encourage him. It is often a good plan to change coaches. It is necessary to do so if the coach shows signs of impatience.

*b. Position of coach.*—The coach will take the same position as the man who is firing, that is, prone, sitting, or kneeling. This enables the coach to watch the pupil's trigger finger and his eye.

*c. Duties of the coach.*—The success of the instruction depends to a great extent on the thoroughness and exactness with which the coach performs his duties. During firing, duties of the coach in addition to those given in paragraph 54 are as follows:

- (1) To require the firer to inspect his rifle.
- (2) To check the sight setting and aiming, requiring them to be correct.
- (3) To observe the firer and see that he re-aims after each shot or burst.
- (4) To require the firer to fire as required for each target.

(5) To point out errors and explain their effect upon the exercises.

(6) To keep constant watch on the adjustment and condition of the gun.

■ 81. To **ALINE FRONT SIGHT**.—*a.* The front sight will be adjusted only as directed by an officer. If the front sight is badly out of alinement, it should be alined by a soldier who has qualified on the record course with the automatic rifle prior to any range firing. If the group contains no such man, the firing and alinement of the sight will be executed by the soldier holding the highest qualification with the service rifle. The 1,000-inch range is the best place to do this because the aiming point is small and well-defined and atmospheric conditions will have no effect on the flight of the bullet.

*b.* In this firing, the windage setting is set at 0 and the soldier aims at the bottom edge of a designated figure on the 1,000-inch target, U. S. rifle, caliber .30, M1. He fires two or more rounds very carefully, using exactly the same aiming point for all shots. The center of the resulting shot group indicates how much and in what direction to move the front sight. The soldier then verifies the front sight adjustment by firing two more rounds.

*c.* If the shot group is to the right of the aiming point, move the front sight to the right; if to the left, move the front sight to the left. To move the strike of the bullet 1 inch at a range of 1,000 inches requires a movement of the front sight of only twenty-five out-thousandths inch.

■ 82. To **DETERMINE ZERO OF RIFLE**.—Each rifle will be "zeroed" for the 1,000-inch range in the firing provided for that purpose in table I. Each rifle will be zeroed for 300 and 500 yards during the instruction practice provided for those ranges. Each man will keep a record of these zeroes in his score book. It will be noted that the lowest graduation on the rear sight leaf is 300 yards. When the rifle is fired at 200 yards with a sight setting of 300 yards, a shot will hit the target approximately 6 inches above the point of aim. However, since the dimensions of the silhouette of the D target are 26 inches wide and 19 inches high, a shot fired at 200

yards with a sight setting at 300 yards will be well within the silhouette.

*a. To zero rifle for 1,000-inch range.*—(1) The target for the 1,000-inch range is so devised that when aim is accurately taken at 6 o'clock on a black silhouette the center of a shot group should be in the center of the same silhouette.

(2) The first two or more rounds are fired on the black silhouette of figure No. 1, with the sight set as low as possible and zero windage. Corrections in elevation and windage to bring subsequent shots into the center of the black silhouette are set by the elevating and windage knobs. Such corrections are applied after every two or more shots under the direction of an instructor. If the visibility of the shot groups is limited, the instructor after taking necessary safety precautions may move along the line of targets and announce the corrections to the coaches in terms of clicks. One click equals approximately 1 inch on the target on the 1,000-inch range.

*b. To zero rifle for known-distance ranges.*—(1) *General.*—The position of the spotters on the target will permit the necessary corrections in elevation and windage to be computed by the elevating and windage rules. They are then applied as clicks to the sight. These sight settings should be made under the supervision of an instructor or experienced coach after groups of two or more rounds are fired.

(2) *At each range.*—Set the elevation at the desired range. Set the windage at 0. Fire a group of two or more rounds. Then apply correction in clicks of elevation and windage to bring the center of the shot group into the center of the target. Record these corrections in the score book as the zero for that range.

■ 83. INSTRUCTION PRACTICE ON 1,000-INCH RANGE.—*a.* Instruction practice on the 1,000-inch range will conform to the regulations given in section V for record practice except that coaching is permitted and additional personnel to score targets are not required.

*b.* Each exercise on the 1,000-inch range will be preceded by an appropriate fire order.



(1) The form of fire order for firing without time limit is as follows:

- (a) Announce the position.
- (b) Figure 1.
- (c) ——— rounds single shot, with ball cartridges, LOAD.
- (d) COMMENCE FIRING.
- (e) CEASE FIRING.
- (f) CLEAR RIFLE.

(2) For firing with time limit, the form of the fire order is as follows:

- (a) Announce the position, number of magazines, and number of rounds per magazine.
- (b) With ball cartridges, LOAD.
- (c) Figures 3 and 4. ——— rounds on each figure in ——— round bursts.
- (d) COMMENCE FIRING.
- (e) CEASE FIRING.
- (f) CLEAR RIFLE.

c. If the 1,000-inch range is equipped with pits and sliding targets similar to those of a known distance range, the fire orders for firing prescribed for the known distance range under paragraph 84 apply except that b(2)(c) above is substituted for paragraph 84b(2)(c).

■ 84. INSTRUCTION PRACTICE ON KNOWN DISTANCE RANGE.—a. Instruction practice is carried out in conformity with the regulations governing record practice as given in section V, except that additional personnel for scoring targets are not required and each firer will have a coach with him on the firing line. The officer in charge of firing may prescribe the sequence of firing the courses of instruction practice.

b. Each exercise on the known distance range will be preceded by an appropriate fire order.

(1) The form of fire order for firing without time limit is as follows:

- (a) Announce the position and number of rounds to be fired.
- (b) With ball cartridges, LOAD.
- (c) Single shots.
- (d) COMMENCE FIRING.
- (e) CEASE FIRING.

(f) CLEAR RIFLE.

(2) For firing with time limit, the form of the fire order is as follows:

(a) Announce the position, number of magazines, and number of rounds per magazine.

(b) With ball cartridges, LOAD.

(c) ——— round bursts.

(d) Ready on the right?

(e) Ready on the left?

(f) READY ON THE FIRING LINE.

(g) CEASE FIRING.

(h) CLEAR RIFLE.

The targets are withdrawn before the exercise starts and the red flag displayed at the center target. The command READY ON THE FIRING LINE is transmitted to the officer on noncommissioned officer in charge in the pits who will have the red flag waved and lowered on its receipt and who will cause the targets to be run up simultaneously 5 seconds after the flag is lowered. Upon the expiration of the proper time interval he causes the targets to be withdrawn. The officer in charge of the firing line gives the commands CEASE FIRING and CLEAR RIFLE when targets are withdrawn.

■ 85. SAFETY PRECAUTIONS.—Safety precautions for observance by troops are self-contained and complete in this manual. Reference to AR 750-10 is necessary for range officers, the officer in charge of firing, and the commander responsible for the location of ranges and the conduct of firing thereon. All officers and men who are to fire or who are concerned with range practice will be familiarized with the following safety precautions before firing is commenced:

a. Danger flags will be displayed at prominent positions on the range during firing. Do not fire unless such flags are displayed.

b. Upon arrival at the range the automatic rifles of an organization will be inspected by the officers to see that chambers and barrels are free from obstruction.

c. All rifles on the range except those in use on the firing line will have bolts in the forward position and magazines withdrawn. Rifles on the firing line will not be loaded without command.

*d.* Consider every rifle to be loaded until it is examined and found to be unloaded. Never trust your memory as to its condition in this respect.

*e.* Never point the rifle in any direction where an accidental discharge may cause harm.

*f.* Firing will not begin on any range until the officer in charge of firing has ascertained that the range is clear and has given the commands **LOAD** and **COMMENCE FIRING**.

*g.* At least one officer will be present at all firing.

*h.* No rifle will be removed from the firing line until an officer has inspected it to see that the bolt is in its forward position and the magazine is withdrawn.

*i.* No person will be allowed in front of the firing line for any purpose until directed by an officer who has ordered all rifles to be cleared and ascertained that the order has been carried out.

*j.* All firing will immediately cease and rifles set at "safe" (or cleared if ordered) at the command **CEASE FIRING**.

*k.* All loading and unloading will be executed on the firing line with the muzzles directed toward the targets. Rifles will never be loaded in rear of the firing line.

*l.* Care will be taken to avoid undue exposure of ammunition to the direct rays of the sun. This creates hazardous chamber pressures.

*m.* Never grease or oil the ammunition.

*n.* See that the ammunition is clean and dry. Examine all live and dummy ammunition. Turn in all cartridges with loose bullets or which appear to be otherwise defective.

*o.* Never fire a rifle with any rust-preventive compound, cleaning patch, dust, dirt, mud, snow, or other obstruction in the bore. To do so may burst the barrel.

*p.* Before leaving the range, all rifles and belts will be inspected by an officer to see that they do not contain ammunition; and men in ranks will be questioned as to whether they have any ammunition in their possession.

*q.* See AR 45-30 for regulations covering report of accident involving ordnance matériel.

*r.* No magazine test or magazine drill will be conducted in rear of the firing line.

## SECTION V

## REGULATIONS GOVERNING RECORD PRACTICE

■ 86. GENERAL.—*a.* Record practice for course A, B, or C is fired on the known distance range. Record practice for course D is fired on the 1,000-inch range. Additional provisions applicable for course D are given in paragraph 116.

*b.* Record practice will follow instruction practice.

*c.* When the record practice of an individual has commenced it will be completed without interruption by any other form of firing. Instruction practice and record practice will not be conducted simultaneously unless the two types of practice are conducted on different parts of the range.

*d.* The officer in charge of firing may at his discretion require record practice upon the day on which instruction practice is completed.

■ 87. FIRE ORDERS.—Every time-fire exercise fired in record practice will be preceded by an appropriate fire order. Suitable forms for such orders are given in section IV.

■ 88. SEQUENCE OF EXERCISES.—The exercises given in the tables for record practice will be fired in the sequence directed by the officer in charge of firing.

■ 89. STOPPAGES.—*a.* When a stoppage occurs which cannot be cleared by operating the operating handle, the firer will call "Time." The officer in charge of firing or one of his assistants will note the time left to complete the exercise and investigate the stoppage. The stoppage will be reduced. If the stoppage was not due to any fault of the firer, he will be authorized to load, aim, and commence firing on command from the officer investigating the stoppage, who will allow him the unexpired time. In cases where the exact time remaining was not determined by the officer in charge, the firer will be allowed 2 seconds per round for the remaining rounds. When time and ammunition permit, the complete exercise will be refired.

*b.* If the stoppage is manifestly the fault of the firer in failing to inspect either the gun, magazines, or ammunition, or is due to incorrect loading or replacing of magazines, no

time will be allowed to complete the firing and only that part of the exercise which was completed will be scored.

c. The firer will be allowed to fire rounds ejected in clearing stoppages.

d. The soldier firing will not be given any information with reference to the location of his previous hits on the incompleting target until the score is completed.

e. Should a breakage occur, the gun will be repaired or a different gun substituted and the exercise completed. If a different rifle is substituted, the firer will be allowed extra rounds to determine the zero of the substituted rifle.

f. The officer in charge or his assistants will render all decisions on stoppages.

g. A firer, firing part of a time-fire exercise, will begin his firing with the entire target exposed.

■ 90. MEN MARKING TARGETS NOT TO KNOW WHO IS FIRING.—Officers and men in the pit will not be informed as to who is firing on any particular target. In case of such violation, the firer will be required to repeat his score and appropriate disciplinary action taken.

■ 91. TARGET DETAILS.—The details in the pit for the supervision, operation, marking, and scoring of targets during record practice consist of officers, noncommissioned officers, and privates as follows:

a. One commissioned officer assigned to each two targets. When it is impracticable to detail one officer to each two targets in the pit, an officer will be assigned to supervise the marking and scoring of not to exceed four targets. In this case the pit scores will be kept by the noncommissioned officer in charge of each target who will sign the score cards. The officer will take up and sign each score card as soon as the complete score is recorded.

b. One noncommissioned officer assigned to each target to direct and supervise the markers. This noncommissioned officer will be selected from an organization other than the one firing on the target which he supervises. If this is not possible the officer assigned to the target will exercise special care to insure correct scoring.

c. One or two privates assigned to operate and mark each target. These privates may be selected from the organization firing on the targets to which they are assigned.

■ 92. ORGANIZATION OF FIRING LINE.—*a.* Scorers seated close to and to the right of the person firing.

b. Telephone operators 5 paces in rear of the firing line.

c. Persons awaiting their turn to fire 10 paces in rear of the firing line.

d. Low arm racks or rifle racks and cleaning racks 20 paces in rear of the firing line.

■ 93. SCORE CARDS AND SCORING.—*a.* Duplicate score cards will be kept, one at the firing point and one in the pit. These cards will be of different colors. The cards at the firing point will bear the date, the man's name, the number of the target, and the order of firing. The pit record card will not show the man's name but will bear the date, the number of the target, and the order firing.

b. Entries on all score cards will be made in ink or with indelible pencil. No alterations or corrections will be made on the card except by the organization commander or officer scorer in the pit who will initial each such alteration or erasure made.

c. The scores at each firing point will be kept by a non-commissioned officer of some organization other than the organization firing on the target to which he is assigned. If this is not possible company officers will exercise special care to insure correct scoring. As soon as the score is completed the score card will be signed by the scorer, taken up, and signed by the officer supervising the scoring. When convenient the score cards are turned over to the organization commander. Except when required for entering new scores on the range, score cards will be retained in the personal possession of the organization commander.

d. In the pit the officer keeps the scores for the targets to which he is assigned. As soon as the score is completed he signs the score card. He turns these cards over to the organization commander at the end of the day's firing. The organization commander will check the pit records against the firing line records. In case of discrepancy between the two the pit record governs.

e. Upon completion of the record firing and after the qualification order is issued, the pit score card of each man will be attached to his score card kept at the firing point. These cards will be kept available for inspection among the company records for 1 year and then destroyed.

■ 94. MARKING.—a. The value of the shot is indicated as follows:

(1) A five by a white disk.

(2) A four by a red disk.

(3) A three by a white disk with a black cross.

(4) A two by a black disk.

(5) A miss by waving a red flag across the front of the target.

(6) Ricochet hits will be counted as a miss and so indicated.

b. Spotters are placed in shot holes before running the target up for marking.

c. The marking begins with the hits of the highest value. The center of the disk is placed over the spotter, then swung off the target and back again to the next spotter, care being taken each time to show the correct face of the disk. The marking must be slow enough to avoid confusing the scorer at the firing point. When one spotter covers more than one shot hole the disk is placed over it the required number of times. Misses are indicated by slowly waving the red flag across the face of the target one time for each miss.

■ 95. PROCEDURE IN FIRING WITHOUT TIME LIMIT.—a. *On the firing line.*—(1) One person only will be assigned to each target in each order.

(2) As the values of each shot are signaled, the scorer announces, in a tone sufficiently loud to be heard by the firer, the target number, the number of the shot, and the value of the hit. The scorer then records the value of the hits on the score card.

(3) In the event that more than one round is fired in an exercise calling for single shots, the number of rounds fired in the burst will be scored as though they were fired singly.

(4) Whenever a target is marked before the individual who is assigned thereto has fired, as will occur when another

man fires on the wrong target, the scorer will notify the officer in charge of firing. The latter will notify the officer in the pit assigned to the target to disregard the shot. This precaution is necessary to prevent errors in the pit record.

(5) When an individual fires on the wrong target, he will not be scored a miss until the target to which he is assigned has been pulled down and the miss signaled from the pit.

(6) If the target is not half-masked at the completion of a score thereon, or if it is half-masked at the wrong time, the officer in charge of that firing point will adjust the matter at once over the telephone. This precaution is necessary to prevent the error from being carried on through the scores that follow.

*b. In the pit.*—(1) The target is withdrawn and marked after each shot.

(2) In the event that more than one round is fired in an exercise calling for single shots, the number of rounds fired in the burst will be marked as though they were fired singly.

(3) When a shot is fired at a target it is pulled down. The noncommissioned officer indicates the location of the hit to the officer assigned to the target who announces its value and records it on the score card. A spotter is then placed in the shot hole, the previous shot hole if any is pasted, and the target is run up and marked. The noncommissioned officer supervises the marking of each shot. The officer also exercises general supervision over the marking.

(4) When the pit score card indicates a score has been completed, the target is half-masked for about 30 seconds as a signal to the firing line of such completion. At the end of the 30 seconds the target is pulled fully down, the spotter removed, the shot hole pasted, and the target run up for the beginning of a new score.

(5) When a target frame is used as a counterweight for a double sliding target, the blank side of such frame will be toward the firing line.

■ 96. PROCEDURE FOR FIRING WITH TIME LIMIT.—*a. On the firing line.*—(1) One person only will be assigned to a target in each order.

(2) When all is ready in the pit the red flag is displayed at the center target. At that signal the officer in charge of



the firing line will conduct the exercise to be fired in accordance with the procedure given in section IV.

(3) If any individual fails to fire at all he will be given another opportunity. If he fires one or more bursts, the score must stand as his record except as provided in paragraph 89. He will not be permitted to repeat his score on the claim that he was not ready to fire.

(4) As each shot is signaled from the pits it is announced by the scorer at the firing line. A score of 15 shots is announced as follows as each shot is marked: "Target 22; 1 five, 2 fives, 3 fives, 4 fives, 5 fives, 6 fives, 7 fives; 1 four, 2 fours, 3 fours, 4 fours, 5 fours, 6 fours, 7 fours; 1 two." The scorer notes these values on a pad and watches the target as he calls the shot. After marking is finished he counts the number of shots marked, and if it is more or less than 15 calls "Re-mark No. ——." If 15 shots have been marked, he then enters the value of each hit and their total value on the soldier's score card.

*b. In the pit.*—(1) The time of fire allowed for each exercise is regulated by the officer in charge of the pit. The procedure is as follows: The targets are withdrawn before the exercise starts, and the red flag is displayed at the center target. The command **READY ON THE FIRING LINE** is transmitted to the officer or noncommissioned officer in charge in the pits who will have the red flag waved and lowered on its receipt and who will cause the targets to be run up simultaneously 5 seconds after the flag is lowered. Upon the expiration of the proper time interval he causes the targets to be withdrawn.

(2) The officers scoring in the pit examine each of their targets in turn, announce the score, and record it on the pit score cards. Spotters are then placed in the shot holes and the targets run up and marked. The noncommissioned officers supervise the marking of each shot. The officers exercise general supervision over the marking of their targets.

(3) The targets are left up for about 1 minute after being marked. They are then withdrawn, pasted, and made ready for another score. They may be left up until ordered pasted by the officer in charge of the firing line.

(4) If more than the number of shots to be fired are found on any target in record practice, it will not be marked unless all of the hits are of the same value. The officer in charge of the firing line will be notified of the facts by telephone.

■ 97. USE OF TELEPHONES.—*a.* Telephones will be used for official communication only.

*b.* No one will ask over the telephone for information as to the name or organization of any person firing on any particular target, and no information of this nature will be transmitted.

*c.* The following expressions will be used over the telephone in the cases enumerated:

(1) When a shot has been fired and the target has not been withdrawn from the firing position, "Mark No. ———."

(2) When a shot has been fired and a target has been withdrawn from the firing position but not marked, "Disk No. ———."

(3) When the target has been withdrawn from the firing position and marked but the value of the shot has not been understood, "Redisk No. ———."

(4) When the firing line is ready for time fire, "Ready on the firing line."

(5) When a shot is marked on a target and the person assigned thereto has not fired, "Disregard the last shot on No. ———."

■ 98. COACHING PROHIBITED.—Coaching of any nature after the firer takes his place on the firing line is prohibited. No person will render or attempt to render the firer any assistance whatever while he is taking his position or after he has taken his position at the firing line.

■ 99. USE OF INSTRUMENTS.—*a.* The use of field glasses is authorized and encouraged.

*b.* The use of instruments or devices for determining the force and direction of the wind is prohibited during record practice.

■ 100. SHELTER FOR FIRER.—Sheds or shelter for the individual at the firing point will not be permitted at any range.

■ 101. RESTRICTIONS AS TO THE RIFLE.—Troops will use the Browning automatic rifle, caliber .30, M1918A2, as it is issued by the Ordnance Department. The use of additional appliances is prohibited. The sights may be blackened. Ordnance Department test equipment will not be used for determining the classification.

■ 102. AMMUNITION.—The ammunition used will be the service cartridge as issued by the Ordnance Department.

■ 103. CLEANING.—Cleaning is permitted at any time.

■ 104. GUN SLING.—The gun sling will be used as prescribed in this manual for the various positions and in no other manner.

■ 105. PADS AND GLOVES.—*a.* Pads of moderate size and thickness may be worn on both elbows to protect them from bruising. A smooth pad of moderate size and thickness may be worn on the right shoulder. The use of other forms of pads is prohibited. The use of a hook or ridge on the sleeve of the shooting coat or shirt to keep the sling in place on the arm is prohibited.

*b.* A glove may be worn on either hand provided it is not used to form an artificial support for the rifle.

■ 106. WARMING, FOULING, AND SIGHTING SHOTS.—No warming, fouling, or sighting shots will be allowed.

■ 107. SHOTS CUTTING EDGE OF SILHOUETTE OR LINE.—Any shot cutting the edge of the silhouette will be indicated and recorded as a hit in the silhouette. Because the limiting line of each division of the target is the outer edge of the line separating it from the exterior division, a shot touching this line will be indicated and recorded as a hit in the higher division.

■ 108. SCORE INTERRUPTED.—If a score which is being fired without time limit is interrupted through no fault of the person firing, the unfired shots necessary to complete the score will be fired at the first opportunity.

■ 109. MISSES.—Before misses are signaled in record firing, the target will be withdrawn and carefully examined by an officer. Whenever a target is run up and a miss is indi-

cated, it will be presumed that this examination has been thoroughly made. No challenge of the value indicated will be entertained or resigning of the shot allowed.

■ 110. SHOTS TO BE INCLUDED IN SCORE.—All shots fired by the soldier in his proper turn after he has taken his place at the firing line and the target is ready will be considered as part of his score.

■ 111. FIRING ON WRONG TARGET.—Shots fired on the wrong targets will be recorded as misses on the score of the man firing, no matter what the value of the hits on the wrong target may be. The soldier at fault is credited with only such hits as he may have made on his own target.

■ 112. TWO SHOTS ON SAME TARGET.—If two shots strike a target at the same time or nearly the same time, neither will be marked. The individual who fired on his own target will be allowed to fire another shot.

■ 113. WITHDRAWING TARGET PREMATURELY.—If the target is withdrawn from the firing position just as a shot is fired, the scorer at that firing point will at once report the fact to the officer in charge of the scoring on that target. The officer will investigate to see if the case is as represented. Being satisfied that such is the case, he will direct the shot be disregarded and that the man fire another shot.

■ 114. UNFIRED CARTRIDGES IN FIRING WITH TIME LIMIT.—Each unfired cartridge will be recorded as a miss.

■ 115. MORE SHOTS THAN PRESCRIBED IN FIRING WITH TIME LIMIT.—When a target has more than the prescribed number of shots for a time-fire exercise in record practice and these hits are of different values, the target will not be marked. The soldier firing on that target will repeat the firing of his score. If all the hits on the target have the same value, the target will be marked and he will be given the value of the authorized number of shots.

■ 116. RECORD PRACTICE FOR COURSE D, 1,000-INCH RANGE.—*a.* The following special provisions apply only to record practice for course D which is fired on the 1,000-inch range.

b. So much of the foregoing provisions for record practice as can be applied will be followed. Suitable fire orders for use on the type of 1,000-inch range which is equipped with pits and movable targets, as well as suitable fire orders for use on the type of 1,000-inch range which is not so equipped, will be found in section IV.

c. When the record practice is fired on 1,000-inch ranges not equipped with pits and movable targets the following rules will apply:

(1) Sufficient assistants will be detailed from companies other than the ones firing to assist the officer in charge. From the assistants, officers will be detailed as scorers at the rate of one for every four targets.

(2) The officers detailed as assistants will aid the officer in charge in every way possible. They will—

(a) Note deductions for penalties and report same to the scorer (see *e*(3) below).

(b) Note the time out for stoppages and inspect to determine whether the stoppage was due to any fault of the soldier.

(c) Superintend the firing of rounds remaining from stoppages not the fault of the firer.

(d) Scorers will count the bullet holes in each target and report any that have more than the prescribed number.

(e) Scorers will score the targets in accordance with the provisions of *e* below.

*d.* (1) When a stoppage occurs that cannot be cleared by pulling back the operating handle and releasing it, the firer will call "Time." The officer in charge of firing or an assistant will note the time left to complete the exercise. The stoppage will be reduced. The firer will load and complete the firing on command from the officer in charge who will allow the remaining time. In cases where the exact time remaining was not determined by the officer in charge, the firer will be allowed 2 seconds per round for the remaining rounds.

(2) If the stoppage is manifestly the fault of the firer, no time will be allowed to complete the exercise, and only that part of the exercise which was fired will be scored.

(3) Should a breakage occur the gun will be repaired or a different rifle substituted. If a different rifle is substituted

the firer will then be allowed extra rounds to determine the zero of the substituted rifle. He will then complete the exercise.

e. The 1,000-inch record target will be scored in accordance with the requirements for record firing as follows:

(1) The course shown in table II, paragraph 75a, will constitute the record course. The course consists of the five exercises shown in this table and includes a total of 110 shots.

(2) In all exercises the soldier will be credited with five points for hitting the scoring space included within or touching the outer scoring line of each figure at which he fires. In addition he will be credited with one point for each shot placed in or touching this scoring space. Example: In the first exercise the soldier fires his five shots at figure No. 1 and scores five hits. He is credited with five points for hitting the scoring space and an additional point for each shot therein. His total score is ten points.

(3) In all of the exercises except the third a total of five shots only per scoring space will be allowed. Additional shots placed in the scoring space will not be counted. In the third exercise twenty shots will be divided between figures No. 3 and No. 4. Ten rounds should be placed on figure No. 3 and ten rounds on figure No. 4. However, a leeway of one shot in this distribution is permitted, and if the score is divided with eleven shots on one target and nine on the other all hits will be counted. Hits in excess of eleven on either of the targets will not be allowed.

(4) The total possible score for each exercise and for the record course is as follows:

Exercise:	Shots	Total possible scores
First -----	5	10
Second -----	5	10
Third -----	20	30
Fourth -----	40	80
Fifth -----	40	80
Total possible score -----		210

(5) For firing before COMMENCE FIRING or after CEASE FIRING, five points will be deducted for each round so fired.

(6) In case of hits on the wrong target, the firer who received the erroneous hits will refire his score. The firer who placed his hits on the wrong target will count those upon his own and will not be permitted to refire the exercise.

## SECTION VI

### TARGETS AND RANGES

■ 117. **TARGETS.**—The designations and dimensions of the two types of target used for marksmanship courses for the Browning automatic rifle, caliber .30, M1918A2, are as follows:

*a. 1,000-inch target, U. S. rifl, caliber .30, M1 (fig. 23).*—This target is used for fire on the 1,000-inch range. The scoring figures numbered from 1 to 8, inclusive, are utilized in known distance marksmanship (ch. 2). Each of these scoring figures is composed of three silhouettes. These silhouettes are reduced in scale to represent the appearance of target D on the known distance range. The inner silhouette of the 1,000-inch target represents the silhouette of target D at 500 yards; the middle silhouette represents the four space of target D at 300 yards; the outer silhouette target represents the four space of target D at 200 yards. Hits in the inner silhouettes of the 1,000-inch target count 5; in the middle silhouettes, 4; and in the outer silhouettes, 3.

*b. Target D.*—This target is used for all types of fire on the known distance range. It consists essentially of a square target, 6 by 6 feet in dimensions, upon which a black silhouette, representing a prone figure, is centered. Hits in the silhouette count 5, in the next space 4, and in the next 3. Hits on the remainder of the target count 2.

■ 118. **RANGES.**—*a. Suitability.*—Ranges suitable for range firing with the U. S. rifle, caliber .30, M1903 and M1, are equally suitable for range firing with the automatic rifle, caliber .30, M1918A2.

*b. Installation and construction.*—The installation and construction of target ranges for small arms target practice is governed by AR 30-1505. The installation of range communication systems is governed by AR 105-20. Range regulations for firing ammunition in time of peace are given in AR 750-10 and include the safety limits and danger areas of ranges.





*c. Selection of known distance ranges—(1) Direction.*—If possible, a range should be so located that the firing is toward or slightly to the east of north. Such location gives a good light on the face of the targets during the greater part of the day. However, security and suitable ground are more important than direction.

(2) *Best ground.*—The targets should be on the same level with the firer or only slightly above him. Firing downhill should be avoided.

(3) *Size.*—The size of the range is determined by its plan and by the number of troops that will fire over it at a time. There are two general plans used in range construction: one with a single target pit and firing points for each range; the other with firing points on one continuous line, the target pits for the various ranges being in echelon.

(4) *Intervals between targets.*—The targets should be no farther apart than is necessary to reduce the chance of shots being fired on wrong targets. As a general rule, the intervals between targets are equal to the width of the targets themselves. Where the necessity exists for as many targets as possible in a limited space, this interval may be reduced one-half without materially affecting the value of the instruction.

(5) *Protection for markers.*—(a) Protection is provided for the pit details by excavating a pit, by constructing a parapet in front of them, or by a combination of both methods.

(b) Where there are several targets in a row, the shelter should be continuous. It must be high enough to protect the markers. The parapet may be of earth with a timber or concrete revetment of sufficient thickness to stop bullets and from 7½ to 8 feet high above the ground or platform on which the markers stand.

(6) *Artificial butts.*—If an artificial butt is constructed as a bullet stop, it should be of earth not less than 30 feet high and with a slope of not less than 45°. The slopes should be sodded. The provisions of AR 750-10 must also be met by the range.

(7) *Hills as butts.*—A natural hill to form an effective butt should have a slope of not less than 45°.

(8) *Numbering of targets.*—Each target is designated by a number. The numbers for ranges up to 600 yards should be at least 6 feet in height and should be painted black on a white background. Arabic numerals of the size suggested will always be quickly recognized. They should be placed on the butt behind each target or on the parapet in front, and not so far above or below as to prevent the firer seeing the number when aiming at the target.

(9) *Measuring the range.*—The range should be carefully measured and marked with stakes at the firing points in front of each target. These stakes should be about 12 inches above the ground and painted white. Black figures indicate the number of the corresponding target.

(10) *Ranges parallel.*—The different ranges for the same distance should all be parallel so that similar conditions with respect to wind and light may exist.

(11) *Firing mounds.*—If it is necessary to raise a firing point, a low mound of earth no higher than required should be made. The mound should be level, sodded, and not less than 12 feet square. If the entire firing line is raised, the firing mound should be level, sodded, and not less than 12 feet wide on top.

(12) *Pit shed.*—A small house or shed should be built in or near the target pit for storing equipment.

(13) *Danger signals.*—A danger signal will be placed in front of the targets when firing has been suspended. One or more red streamers will be prominently displayed on all ranges and at all times during firing.

(14) *Range house.*—On large ranges a house containing a storeroom and office room is desirable.

(15) *Telephone service.*—Ranges should be equipped with a telephone system connecting the target pit with each firing point, the range house, and the station headquarters. The number of telephones should not be less than one to each 10 targets.

(16) *Electric bells.*—On large ranges the installation for each five targets of an electric bell that can be controlled from a central point in the pit adds materially to the celerity and uniformity of target manipulation for time fire.

(17) *Covered ways between pits.*—Where the pits are in echelon, covered ways or tunnels should be provided between the various pits. This construction will allow the pit details to be shifted with safety without interrupting the firing.

(18) *1,000-inch range.*—A 1,000-inch range without a land danger area behind its backstop must meet the following minimum requirements:

(a) Vertical bulletproof backstop and wing walls (natural or artificial) not less than 30 feet high. Wing walls must cover at least  $15^\circ$  on each flank. In case of artificial wing walls, they should be set at an angle of  $15^\circ$  with the backstop toward the firing points.

(b) Ricochet pit in front of firing points providing at least a  $4^\circ$  slope downward from the normal line of fire from a prone position and extending to within 30 feet of the backstop and wing walls. If a vertical cliff or wall over 40 feet high is available, no ricochet pit need be provided.

## CHAPTER 3

### MARKSMANSHIP, MOVING GROUND TARGETS

	Paragraphs
SECTION I. General.....	119-120
II. Moving vehicles and personnel.....	121-123
III. Moving targets, ranges, and range precautions..	124-125

#### SECTION I

#### GENERAL

■ 119. **GENERAL.**—Personnel armed with the Browning automatic rifle, caliber .30, M1918A2, will be trained to fire at moving targets such as tanks, armored vehicles, trucks, and personnel at appropriate ranges. They will be trained to meet hostile mechanized attack by standing their ground, taking cover, and delivering the maximum possible aimed fire with armor piercing or ball ammunition at the enemy armored vehicles or tanks and at any hostile foot troops which may accompany them. To this end they must be trained in the technique of such fire.

■ 120. **FUNDAMENTALS.**—*a. General.*—The fundamentals of shooting as presented in chapter 2 apply to firing at moving targets. In applying these fundamentals the automatic rifleman must adjust his aim and trigger press to the movement of the target.

*b. Effective range.*—Fire at moving targets is usually opened at ranges under 600 yards, and training in the technique of fire is normally limited to firing at such ranges with the battle sight. Corrections for range are made by adjustment of the aiming point on the target.

*c. Leads.*—Targets which cross the line of sight at any angle are classified as crossing targets. In firing at such targets the firer must aim ahead of the target so that the paths of the target and bullet will meet. The distance ahead of the target is called the "lead." Targets which approach directly toward the firer or recede directly from the firer will for all practical purposes require no lead.

## SECTION II

## MOVING VEHICLES AND PERSONNEL

■ 121. PLACE IN TRAINING.—*a. Vehicles.*—The technique of firing at moving vehicles with service ammunition follows training in known distance marksmanship (ch. 2). When time and ammunition allowances permit, 1,000-inch firing or caliber .22 firing may be added as preliminary instruction.

*b. Personnel.*—As in the case of practice in firing at moving vehicles, instruction in this type of firing should follow instruction in known distance firing and should immediately precede the training of the squad in the technique of fire.

■ 122. MOVING VEHICLES.—*a. Determination and application of leads.*—(1) The lead necessary to hit a moving vehicle is dependent upon the speed of the target, the range to the target, and the direction of movement with respect to the line of sight. Moving at 10 miles an hour a vehicle moves approximately its own length of 5 yards in 1 second. A rifle bullet moves 400 yards in about  $\frac{1}{2}$  second and about 600 yards in about 1 second. Therefore to hit a vehicle moving at 10 miles an hour at ranges of 400 yards and 600 yards, the leads should be  $2\frac{1}{2}$  yards and 5 yards, respectively. At a speed of 20 miles an hour the leads should be 5 yards and 10 yards, respectively.

(2) Leads are applied by using the length of the target as it appears to the firer as the unit of measure. This eliminates the necessity for corrections due to the angle at which the target crosses the line of sight, because the more acute the angle the smaller the target appears and the less lateral speed it attains. The following lead table is furnished as a guide:

TARGET LENGTH LEADS

Target speed in miles per hour	For ranges of 400 yards or less	For ranges of 400 to 600 yards
10	$\frac{3}{4}$ TL	1 TL.
20	1 TL	2 TL.

(3) As an average rule, troops should be instructed to use a lead of 2 target lengths in firing at fast moving targets and of 1 target length against targets which appear to move slowly or to follow an interrupted course.

*b. Technique of fire.*—(1) The following technique is employed for firing at moving targets at ranges of 600 yards or less. The battle sight is used. Corrections for range are made by aiming at the top of the target at 600 yards and lowering the aim to the bottom as the target approaches the firer.

(a) *Approaching or receding targets.*—The firer holds his aim on the target in firing.

(b) *Crossing targets.*—The firer swings his line of sight through the target and out to the estimated lead. The automatic rifle is kept swinging ahead of the target at the prescribed lead in firing.

(2) Fire is executed as rapidly as proper aiming and pressing of the trigger will permit.

■ 123. METHOD OF AIMING AT MOVING PERSONNEL.—*a.* An elaborate system of calculating leads or of setting sights is neither necessary nor desirable. The following general rule is used with the battle sight. When firing at a man walking across the line of fire the point of aim at the various ranges is taken as follows:

(1) At ranges of 0 to 200 yards, aim directly at the lower part of the body.

(2) At ranges greater than 200 yards, aim at the lower part of the body and lead him the width of his body.

*b.* When firing at a man advancing or receding from the firer with the battle sight, choose a point of aim as indicated in paragraph 122b(1)(a).

### SECTION III

#### MOVING TARGETS, RANGES, AND RANGE PRECAUTIONS

■ 124. MOVING TARGETS AND RANGES.—*a. Firing at moving vehicles.*—(1) *Target.*—A sled of the type shown in figure 24 has proved to be the most satisfactory kind of target. It has the advantage of a low center of gravity which prevents

upsetting on rough ground and in making changes of direction. The sled shown in the figure is  $5\frac{1}{2}$  by  $3\frac{1}{2}$  by  $4\frac{1}{2}$  feet high and weighs only 45 pounds. Figure 25 shows a similar sled covered with target cloth.

(2) *Towing*.—For towing the target a  $\frac{1}{2}$ -inch rope has been found satisfactory, the power being furnished by a  $1\frac{1}{2}$ -ton truck. The pulley shown in figure 25 is simply a channel wheel bolted to a short length of 2-inch board. This board is staked to the ground at a point where a change

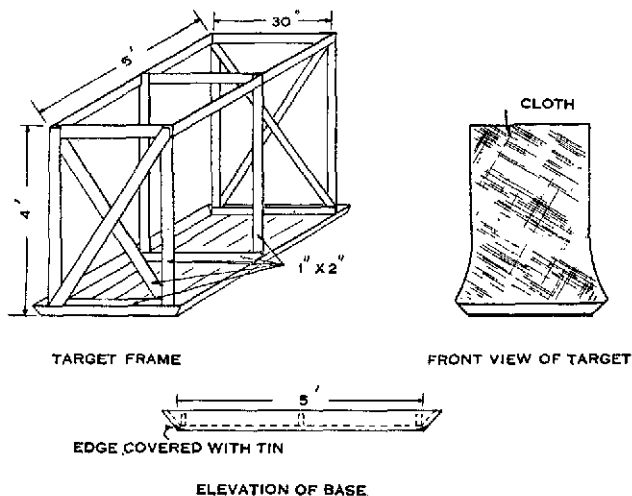

FIGURE 24.—Target frame for moving target range.

of direction of the target is desired. The knot shown in the figure should be 10 or 12 feet from the sled, depending on the speed at which the target is to be run. At faster speeds the knot must be at a greater distance from the sled to prevent the increased momentum of the sled from overrunning the pulley.

(3) *Set-up*.—With 500 yards of rope, a set-up as shown in figure 26 can be made. This set-up is only one of many possible to make with 500 yards of rope. Accidents incident to wrong laying may be prevented by keeping just in rear of

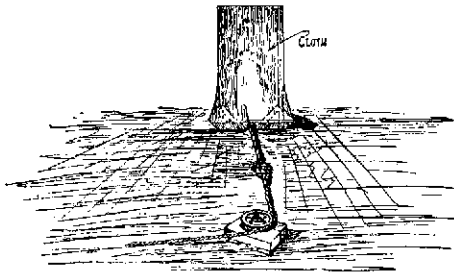
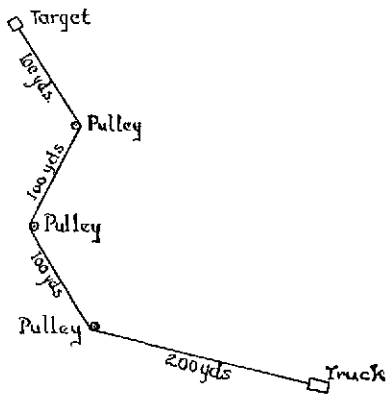

FIGURE 25.—Sled target covered with target cloth; pulley and trip knot for effecting changes of direction.



• GUN

FIGURE 26.—Set-up for towing a target.



the gun a safety officer whose duty is to see that the barrel is kept pointed in a direction not too near the truck. The essential elements in training a gun squad to fire at moving targets are much practice for the observer in estimating angular speeds and for the gunner in laying on a target in motion, and for everybody, *speed*.

*b. Firing at moving personnel.*—Any class A range is suitable for this purpose. E targets on sticks carried by men walking in the pits are sufficient.

■ 125. RANGE PRECAUTIONS.—For general range precautions including danger areas see AR 750-10. In addition to the individual safety precautions prescribed in chapter 2, the following precautions will be observed:

*a. Firing at moving targets* will not be permitted on any range until the safety angles have been carefully checked and markers have been placed so as to define clearly the right and left limits of fire.

*b. Personnel of trucks towing moving targets* will operate at such distance from the line of fire as to be protected not only from direct hits but from ricochets.

*c. Trucks replacing targets on the course or personnel effecting repairs* will be equipped with red flags.

## CHAPTER 4

### MARKSMANSHIP, AIR TARGETS

	Paragraphs
SECTION I. General .....	126
II. Technique of antiaircraft fire.....	127-131
III. Marksmanship training.....	132-136
IV. Miniature range practice.....	137-140
V. Towed target firing.....	141-145
VI. Ranges, targets, and equipment.....	146-151

#### SECTION I

#### GENERAL

■ 126. AIR TARGETS.—*a. Suitable for automatic rifle fire.*—Combat arms take the necessary measures for their own immediate protection against low-flying hostile aircraft. Therefore all troops must be fully trained and imbued with the determination to protect themselves against hostile aerial attacks without reliance upon other arms. Low-flying hostile airplanes are suitable targets for automatic rifle fire.

*b. Classification.*—From the point of view of the automatic rifleman, air targets may be classified as—

(1) *Overhead.*—Those which pass over or nearly over the automatic rifleman. Overhead targets which dive directly toward the automatic rifleman are called direct diving targets; those which climb directly away from the automatic rifleman are called direct climbing targets.

(2) *Nonoverhead.*—Those which do not pass over or nearly over the automatic rifleman.

#### SECTION II

#### TECHNIQUE OF ANTI-AIRCRAFT FIRE

■ 127. GENERAL.—Airplanes present very fleeting targets and must be engaged promptly by all available weapons. This section on the technique of fire deals with placing automatic rifle fire on hostile low-flying planes. Details of antiaircraft marksmanship training which deal with firing on various

types of moving or towed targets are contained in sections III, IV, and V.

■ 128. LEADS.—*a. General.*—In order to hit an airplane in flight, the firer must aim ahead of the target so that the paths of the bullet and target will meet. The distance ahead of the airplane is called the "lead." A lead must be applied in all firing except when the target is at an extremely close range (100 feet), or when it is diving directly at the firer or climbing directly away from him.

*b. Application of leads.*—The length of the target as it appears to the firer is used as the unit of measure for applying leads. The number of times the firer applies this unit of measure is explained in paragraph 131.

■ 129. TARGET DESIGNATION.—*a.* Attacking aviation will often fly in V-shaped formations of three or more airplanes each. Therefore each one of the three airplanes of a typical hostile flight may be designated as a target for an element of the rifle platoon. For example, the first rifle squad is assigned to fire on the leading airplane; the second rifle squad on the right airplane; and the third rifle squad on the leading airplane or airplanes.

*b.* Automatic riflemen should assume the firing position as soon as possible after receiving warning of the approach of hostile airplanes and track the target until it comes within range.

■ 130. INDIVIDUAL TECHNIQUE OF ANTI-AIRCRAFT FIRE.—*a.* For all direct diving or climbing planes, aim and fire each shot at the target.

*b.* For all targets except direct diving or climbing planes, aim and fire each shot with a lead of four target lengths. The target considered in determining the lead of four target lengths is a 30-foot airplane. In using this method for towed target firing, the lead will have to be changed in accordance with the length of the target.

*c.* The battle sight is used in all firing at aerial targets. For all targets except direct diving or climbing planes, aim well above the target at ranges over 300 yards.

■ 131. DELIVERY OF FIRE.—*a.* Each shot must be aimed, the trigger pressed and released quickly. Fire should not be per-

mitted at faster rates than will permit careful aiming and trigger manipulation. Single shots are usually employed.

*b.* Automatic rifle fire is a serious hazard to low-flying planes and if unhesitatingly delivered will tend to discourage such missions. Hits will frequently cause the plane to crash, and even if the effects of hits cannot be immediately observed may have caused serious damage.

*c.* The four target length lead prescribed in paragraph 130b is suitable for firing on hostile planes which have a speed of around 200 miles per hour. This lead should be proportionately increased for hostile planes having much greater speed. (See par. 218c.)

### SECTION III

#### MARKSMANSHIP TRAINING

■ 132. GENERAL.—*a. Object of instruction.*—The object of automatic rifle antiaircraft marksmanship instruction is to train the automatic rifleman to fire effectively at rapidly moving aerial targets.

*b. Basis of instruction.*—(1) Prior to instruction in antiaircraft marksmanship the automatic rifleman should have completed known distance marksmanship (ch. 2) and his firing at moving ground targets (ch. 3). To become a good antiaircraft marksman he must be able to apply the fundamentals of marksmanship to firing at rapidly moving targets, and to perform the following operations with accuracy and precision:

(*a*) Apply the length of the target as a unit of measure in measuring the required lead.

(*b*) Aline the sights of the rifle at the required lead rapidly.

(*c*) Swing the rifle with a smooth, uniform motion so as to maintain the aim on the required lead while pressing the trigger and during the forward motion of the bolt.

(*d*) Properly apply the trigger press so as to get a shot off in a minimum of time and without disturbing the aim.

(2) The course of training outlined in this section is intended to train the soldier to obtain the correct performance of the four operations combined into one continuous, smooth

motion when firing in any direction at rapidly moving aerial targets.

*c. Sequence of training.*—Antiaircraft automatic rifle marksmanship is divided into preparatory exercises, miniature range practice, and towed target firing.

*d. Personnel to receive training.*—Officers and men as covered in AR 775-10 will receive antiaircraft training.

■ 133. PREPARATORY EXERCISES.—*a. General.*—(1) *Description.*—The preparatory exercises consist of the following three distinct steps which will be completed on each of the targets described hereafter prior to firing on those targets:

Position exercise.

Aiming and loading exercise.

Trigger manipulation exercise.

(2) *Method.*—The coach and pupil method will be carried on throughout the training. In the preparatory exercises each coach will observe and correct his pupil to see that the following points as applicable are observed:

(a) Proper position is taken.

(b) Slack is taken up promptly and firmly.

(c) Automatic rifle is swung with a smooth, uniform motion.

(d) Automatic rifle is swung by pivoting the body at the waist.

(e) Arms, shoulder, automatic rifle, and head move as a unit as the automatic rifle is swung.

(f) Pressure on the trigger is applied promptly, decisively, and continuously.

(g) Eye is kept open and does not blink on the forward motion of the bolt.

(h) Muzzle does not jerk coincident with the release and forward motion of the bolt.

(i) Pupil continues the aim during the entire length of travel of the target.

(j) Pressure on trigger is released quickly upon the release of the bolt.

*b. Organization.*—With the targets and target range described hereinafter (sec. VI), a group of 32 men per target is the most economical training unit. This group is formed

in two ranks of 16 men each. For the preparatory exercises this will permit 16 men to perform the exercises on each type of target while the remaining 16 men act as coaches. (See fig. 27.) When firing the Browning automatic rifle, caliber .30, M1918A2, the interval between individuals on the firing line should be increased. This is accomplished by placing only one-half the group on the firing line at one time. Each group should complete all preparatory training and instruction firing on its assigned



Nonoverhead target.

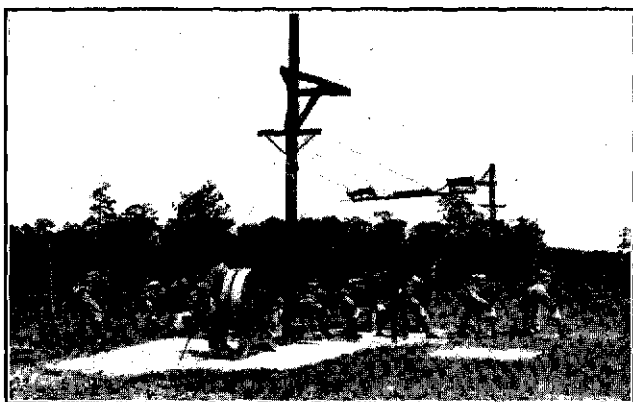

③ Overhead target.

FIGURE 27.—Organization for training.

target. Groups then change places. The preparatory training and instruction firing is then undertaken on the new type of target. This procedure will be followed until each man of each group has completed his instruction on each of the four types of targets.

■ 134. FIRST STEP: POSITION EXERCISES.—*a.* The kneeling or standing position is generally used in antiaircraft firing.

*b.* (1) These antiaircraft firing positions differ from those used in firing at ground targets in that—

(*a.*) The sling is not used.

(*b.*) The arms move freely in any direction with the body.

(*c.*) The hands grasp the piece firmly.

(*d.*) The butt of the automatic rifle is pulled hard against the shoulder with the right hand, and the cheek is pressed against the stock.

(*e.*) In the kneeling position the buttock does not rest on the heel, and the left foot is well advanced to the left front. The weight is slightly forward.

(2) The positions must be such that the automatic rifle, the body from the waist up, the arms, and the head can move as a unit.

(3) When leading a target the automatic rifle is swung with a smooth, uniform motion. This is accomplished by pivoting the body at the waist. There is no independent movement of the arms, the shoulders, the head, or the rifle.

(4) The instructor explains and demonstrates the position. He points out that if the automatic rifle is pulled or pushed in the desired direction by means of the left hand and arm a jerky motion instead of the smooth swing necessary for correct aiming and trigger manipulation will result.

(5) Position exercises are conducted so that the automatic riflemen become proficient in rapidly assuming positions for firing at hostile aircraft moving in any direction.

■ 135. SECOND STEP: AIMING AND LEADING EXERCISES.—*a. Purpose.*—The purpose of the aiming and leading exercises is to teach the correct method of aiming and to develop skill in swinging the automatic rifle with a smooth, uniform motion.

*b. Method.*—(1) For the instruction of the groups assigned to the nonoverhead target (fig. 28①), the pupils in the kneel-

ing firing position are placed in one line at about  $1\frac{1}{2}$  yards interval, 500 inches from and facing the assigned target. The coaches take position, so they can observe the pupils. The commands for the exercise are: 1. AIMING AND LEADING EXERCISE, 2. ONE (TWO) TARGET LENGTH LEADS, 3. TARGETS. At the command TARGETS, the targets are operated at a speed of from 15 to 20 feet per second. Each pupil alines his sights on the spotter indicating the proper lead and takes up the slack in his trigger. He then swings his rifle with a smooth, uniform motion by pivoting the body at the waist and maintains the aim on the proper lead during the travel of the target. The operation is repeated as the target is moved in the opposite direction. The exercise is continued until the target has been moved four times in each direction. The coach and pupil then change places, and the exercise is continued until all men have acquired some skill in aiming and leading with one, two, and three target length leads, both from right to left and left to right.

(2) For the instruction of the group assigned to the overhead target (fig. 28 ②), the line is formed perpendicular to and facing the line of flight of the target. The procedure is the same except that one target length lead only is used.

### ■ 136. THIRD STEP: TRIGGER MANIPULATION EXERCISES.—a.

*General.*—(1) The automatic rifleman is trained to press the trigger exactly as when firing at stationary targets except that the automatic rifle is kept in motion during the trigger press, the forward motion of the bolt, the firing of the shot, and momentarily after the firing of the shot.

(2) In firing at a rapidly moving target, the untrained man has a tendency to permit the automatic rifle to come to rest momentarily while applying the final trigger press or during the forward motion of the bolt. This results in the shot going behind the target. Another fault of the untrained man is that of jerking the trigger quickly the instant the aim is on the required lead.

(3) Due to the short period of time during which the usual aerial target will be within effective range, fire is opened as soon as possible and delivered at as rapid a rate as possible consistent with accuracy. The trigger is therefore pressed aggressively and decisively. Once started, the press is con-



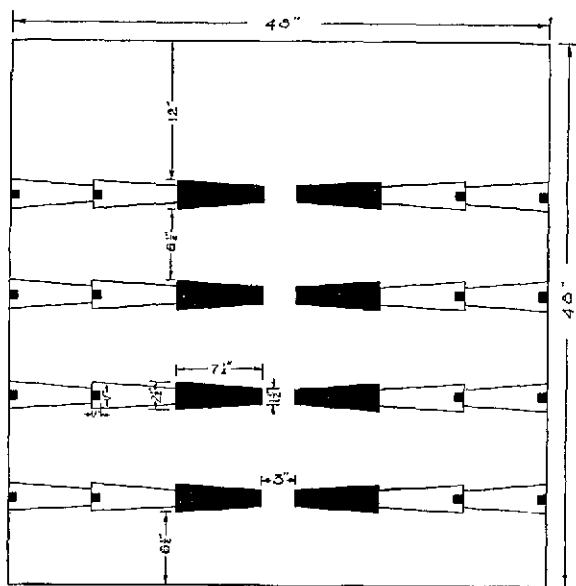

① Nonoverhead.

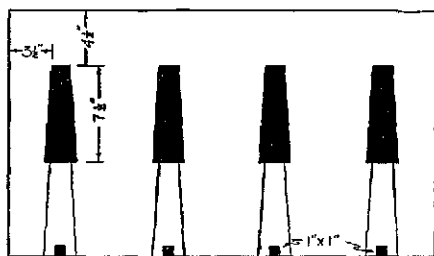

③ Overhead.

FIGURE 28.—Aiming and leading targets.

tinued until the bolt is released and then is released quickly.

*b. Object.*—The object of the trigger manipulation exercises is to train the automatic rifleman to apply pressure on the trigger while keeping the automatic rifle in motion, to develop a decisive trigger press so that fire can be opened in a minimum of time without loss of accuracy, to release the trigger quickly upon the release of the bolt, and to train him to follow through with the shot.

*c. Method.*—(1) Trigger manipulation exercises are conducted in a manner similar to the aiming and leading exercises. The same targets are used but the spotters indicating the various target length leads are removed (fig. 29).

(2) The pupils in the kneeling firing position are placed in one line at about  $1\frac{1}{2}$  yards' interval, 500 inches from and facing the assigned nonoverhead target. The coaches take position so they can observe the pupils. The commands for the exercise are: 1. SIMULATE LOAD, 2. TRIGGER MANIPULATION EXERCISE, 3. ONE (TWO) TARGET LENGTH LEADS, 4. TARGETS. At the command TARGETS, the targets are operated at the proper speed. Each pupil takes up the slack in his trigger, estimates the lead announced in the order and applies that lead by swinging the automatic rifle in the manner learned in the aiming and leading exercise, and maintains his aim at the proper lead while applying a constantly increasing pressure on the trigger until the bolt is released. The aim is continued during the entire length of travel of the target regardless of release of the bolt. The pressure on the trigger is released quickly upon the release of the bolt. The importance of following through with the shot must be emphasized. It is by this means that automatic riflemen develop the habit of keeping their automatic rifles in motion during the process of firing. All of the steps explained above are performed in one continuous operation. The exercise consists of having the pupils press the triggers and then release them quickly each time the target moves across the front. The exercise for each man consists of four passages of the target in each direction. The coach and pupil then change places and the work is continued until all men have become proficient in pressing and releasing the trigger correctly using various target length leads.

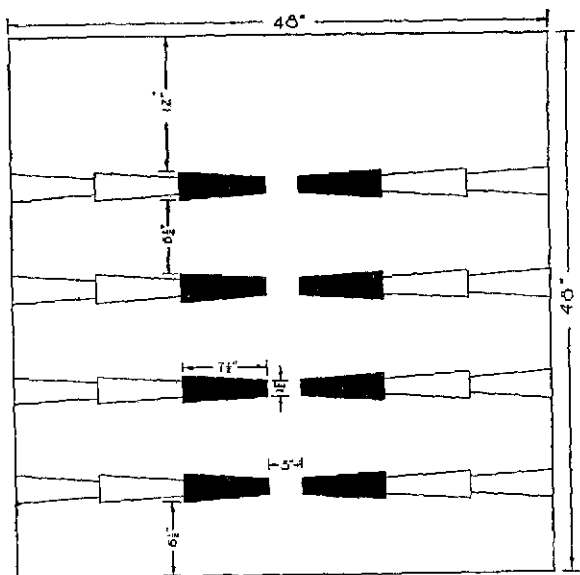

① Nonoverhead.

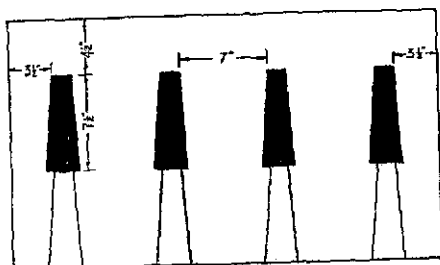

② Overhead.

FIGURE 29.—Instruction targets.

(3) The procedure for overhead trigger manipulation exercise is the same except that the line is formed perpendicular to and facing the flight of the target and one target length lead only is used.

#### SECTION IV

#### MINIATURE RANGE PRACTICE

■ 137. GENERAL.—*a.* Miniature range practice is divided into two parts, instruction firing and group firing. There is no record firing.

*b.* All firing is on moving targets on the 500-inch range. A suggested arrangement of the range is given in section VI. Provision is made for simultaneous firing by separate groups on horizontal, diving, climbing, and overhead targets.

*c.* The course is fired with the Browning automatic rifle, caliber .30, M1918A2, if ammunition and danger area permit. If not, the bolt action U. S. rifle, caliber .22, M1922M1 or M1922M2, may be used.

*d.* All rifles are zeroed before range practice starts.

■ 138. SAFETY PRECAUTIONS.—*a.* The safety precautions given in paragraph 85 are applicable to this firing and will be observed.

*b.* If firers are permitted to go forward to inspect their targets, rifles will be left on the firing line. If the Browning automatic rifle, caliber .30, M1918A2, is used, bolts will be in their forward position and magazines withdrawn. If the caliber .22 rifle is used, bolts will be left open and clips withdrawn.

*c.* Target operators will remain behind the protective wall except when ordered to leave by the officer in charge of the target which they are operating.

*d.* If the caliber .22 rifle is used, the bolt will not be forced home if difficulty in feeding is experienced. Attempting to force the bolt home may result in igniting a rim fired cartridge before the cartridge is chambered.

■ 139. INSTRUCTION FIRING.—*a. General.*—(1) The purpose of instruction firing is to teach the soldier to apply the fundamentals taught in the preparatory exercises to actual firing.

(2) During instruction firing each soldier works under the supervision of a coach.

(3) As a group completes the preparatory training on a target, instruction firing should be taken up on that target and completed before the group moves to another target.

(4) Instruction firing consists of that indicated in table I below.

*b. Procedure.*—(1) As the instruction firing on each type of target follows immediately after the preparatory exercises on that target, the organization of the training unit for firing should be the same as that given in paragraph 133*b*.

(2) The front rank of each group is formed on the firing line in the kneeling firing position. The rear rank men act as coaches.

(3) One-half of the front rank of the group fires while the remaining front rank men simulate firing.

(4) A silhouette is assigned to each individual firer. For example, the four silhouettes on the right of the target are assigned the first four men on the right of the line; the four silhouettes on the left of the target are assigned the next four men. Silhouettes for the men simulating firing are assigned in the same manner, i. e., the right four are assigned silhouettes on the right of the target and the left four are assigned silhouettes on the left of the target.

(5) The officer in charge of the target commands: 1. LOAD, 2. ONE (TWO) TARGET LENGTH LEADS, 3. TARGETS. At the command TARGETS, the targets are operated at the proper speed. Men assigned silhouettes on the right half of the nonoverhead target aim and fire in accordance with the method learned in the trigger manipulation exercise (par. 136*c*(2)). They fire one round each time the target crosses from their right to left. Men assigned silhouettes on the left half of the nonoverhead target fire one round each time the target crosses from left to right.

(6) Men assigned silhouettes on the overhead target fire one round each time the target is run in the approaching direction in the same manner as explained above.

(7) Four rounds constitute a score. After each string of four rounds, targets are scored and shot holes penciled.

(8) One point is awarded for each hit in the silhouette when using one target length, or in the proper scoring space when using more than one target length lead.

(9) Half-groups alternate firing and simulating firing.

(10) When front rank men have fired one score as the target moved in each direction, they change places with the men in the rear rank and act as coaches.

(11) This procedure is followed until all men of the group have performed the required firing.

(12) Upon completion of the firing prescribed in table I for any type of target, the group moves to another type target and continues until all have completed the instruction firing.

(13) Modifications of the above method of firing to meet local conditions are authorized.

TABLE I.—*Instruction firing (range 500 inches).*

Target	1 lead, 8 rounds	2 leads, 8 rounds	3 leads, 8 rounds	Total
Horizontal...	4 rds. R to L.....	4 rds. R to L.....	4 rds. R to L.....	} 24
	4 rds. L to R.....	4 rds. L to R.....	4 rds. L to R.....	
Climbing...	4 rds. R to L.....	4 rds. R to L.....	4 rds. R to L.....	} 24
	4 rds. L to R.....	4 rds. L to R.....	4 rds. L to R.....	
Diving.....	4 rds. R to L.....	4 rds. R to L.....	4 rds. R to L.....	} 24
	4 rds. L to R.....	4 rds. L to R.....	4 rds. L to R.....	
Overhead...	4 rds. approaching.....	4 rds. approaching.....	} -----	} 16
	4 rds. receding.....	4 rds. receding.....		

Speed of all targets, 15 to 20 feet per second. Total rounds, 88.

■ 140. GROUP FIRING.—*a. General.*—(1) Group firing is the final phase of antiaircraft marksmanship training on the miniature range.

(2) It provides for competitions and illustrates the effectiveness of the combined fire of a number of automatic riflemen.

(3) Group firing will not be undertaken until the preparatory training and instruction firing have been completed.

*b. Procedure.*—(1) Two silhouettes, one to be fired upon as the target moves from left to right and one to be fired upon as the target moves in the opposite direction, are assigned to each squad or similar group.

(2) Each man of the front rank followed by each man in the rear rank fires four rounds at each silhouette as the target moves in the appropriate direction.

(3) Targets are scored after completion of the firing of the entire squad or group.

*c. Scoring.*—A value of 1 is given each hit on the silhouette.

*d. Score card.*—A sample score card is shown in paragraph 147e.

## SECTION V

### TOWED TARGET FIRING

■ 141. GENERAL.—*a.* Towed target firing is the final phase of automatic rifle antiaircraft marksmanship. It is conducted on the towed target range described in section VI.

*b.* It consists of firing with caliber .30 ball or tracer ammunition at a sleeve target at various ranges and on varied courses.

*c.* Towed target courses prescribed herein are guides which may be modified. Safety measures and ammunition requirements restrict the length of the course. Safety measures also prevent the adoption of courses to include direct diving or direct climbing targets.

*d.* Towed target firing will follow miniature range instruction firing. If, due to lack of facilities, a unit is unable to conduct miniature range firing it may be permitted to conduct towed target firing provided antiaircraft marksmanship preparatory training has been completed.

■ 142. COURSES TO BE FIRED.—*a.* Units authorized to fire will fire one or more of the courses enumerated in table II.

TABLE II.—*Courses to be fired*

Course No.	Type of flight	Altitude of target	Horizontal range of course (yards) <sup>1</sup>	Speed	Remarks
1	Nonoverhead—horizontal (parallel to firing line from left to right).	Minimum consistent with safety.	Minimum 100; maximum depends on width of danger area of range.	Maximum possible.	See fig. 39.
2	Nonoverhead—horizontal (parallel to firing line from right to left).	do.....	do.....	do.....	See fig. 39.
3	Overhead (perpendicular to firing line).	do.....	Minimum, maximum—in accord with safety precautions.	do.....	See fig. 40.
4	Combined courses Nos. 1, 2, and 3.	do.....	Same as for courses Nos. 1, 2, and 3.	do.....	See fig. 41.

<sup>1</sup> The horizontal distance from the firing point directly under the target.

The maximum slant range for all courses should not exceed 600 yards.

■ 143. SAFETY PRECAUTIONS.—*a.* Towed target firing will be conducted with due regard for the safety of the pilot of the towing airplane, the personnel engaged in firing, and all spectators.

*b.* All firing is controlled by suitable signals or commands. COMMENCE FIRING and CEASE FIRING are given in such a manner as to be understood clearly and promptly by everyone engaged in firing.

*c.* The signals and commands COMMENCE FIRING and CEASE FIRING will be given at such times as to prevent any bullets from falling outside the danger area.

*d.* For all overhead flights, the signal or command COMMENCE FIRING will not be given until the towing plane has



reached a point 50 yards or less, measured horizontally on the ground from the firing point, and there is no danger of bullets striking the plane. The signal or command **CEASE FIRING** will be given when the sleeve target is at least 100 yards, measured horizontally on the ground, in advance of the firing line so there is no danger of bullets dropping outside the firing area.

*e.* Whenever a towing cable breaks and the towing airplane is on a course which passes near the firing point, all personnel in that vicinity will be warned to lie flat on the ground until danger from the loose cable and the release is passed.

*f.* No automatic rifle will be pointed at or near the towing airplane. All tracking will be on the towed target. Muzzles will be depressed during loading.

*g.* At least two safety officers will be designated to assist the officer in charge of firing in carrying out safety precautions.

*h.* To provide for the safety of the towing airplane, firing will be permitted only when the smaller angle in space between the gun-target line and the towline (or towline extended) is greater than 45°.

*i.* An Air Corps officer should be at the firing point during an organization's initial practice for the season for the purpose of giving supplemental instruction and checking the safety measures taken.

*j.* Additional safety precautions are covered in AR 750-10.

■ 144. PROCEDURE OF FIRING.—*a.* The men to fire take the antiaircraft kneeling firing position on the firing line with at least 1½ yards between men.

*b.* The officer in charge of firing takes position in rear of the center of the firing line.

*c.* Safety officers take position at either flank of the firing line.

*d.* As the towing airplane approaches the left (right) side of the danger area, the officer in charge of firing gives the command: 1. (SO MANY) ROUNDS, LOAD, 2. SLEEVE TARGET APPROACHING FROM THE LEFT (RIGHT). Each automatic rifleman loads his piece and sets it at "safe."

*e.* As the towed target approaches the danger area, the officer in charge of firing commands: 3. FOUR TARGET LENGTH LEADS. (See par. 218c.) At this preparatory command, each

automatic rifleman unlocks his piece, aims by swinging through the sleeve to the announced lead, pivoting at the waist, and maintains his estimated lead.

*f.* In firing at crossing targets the safety officer stationed at the end of the firing line opposite to the target's approach gives the signal or command **COMMENCE FIRING**, when the sleeve target has completely crossed the line marking the firing area. The officer in charge of firing and such assistants as he desires repeat the command or signal to insure that all firers hear it. Each automatic rifleman presses the trigger until bolt is released and then releases the pressure on the trigger quickly. He then re-aims rapidly and continues firing until the command or signal **CEASE FIRING** is given. The safety officer at the end of the firing point opposite to the target's departure observes the flight of the sleeve target during the firing. When he observes that the sleeve is about to leave the danger area he gives the signal or command **CEASE FIRING**. The officer in charge of firing and his assistants repeat the command or signal to insure that all firers hear it.

*g.* In firing at overhead targets the same procedure is followed except that the officer in charge of firing, from his position behind the center of the firing line, determines when firing commences and ceases. He gives the command or signal **COMMENCE FIRING** when the towing plane is 50 yards or less in advance of the firing line and **CEASE FIRING** before the sleeve is 100 yards in advance of the firing line. (See par. 143.)

■ 145. **SCORING.**—*a.* The number of hits is found by dividing the number of holes in the target by two. An odd hole is counted as a hit.

*b.* The hit percentage is obtained by dividing the number of hits as obtained in *a* above by the total number of rounds fired at the target.

## SECTION VI

### RANGES, TARGETS, AND EQUIPMENT

■ 146. **RANGE OFFICER.**—A range officer is appointed well in advance of range practice. His chief duties are stated in paragraph 77*b*.

■ 147. MINIATURE RANGE.—*a*. The miniature range consists of—

- (1) One horizontal target (fig. 30①).

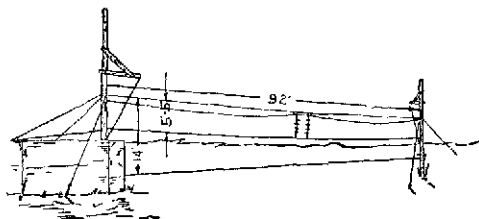

① Horizontal

- (2) One double climbing and diving target (fig. 30②).

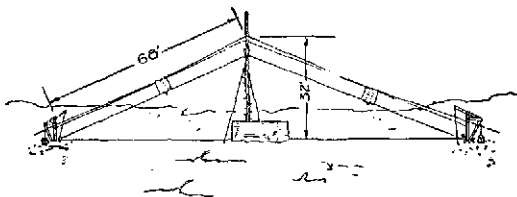

② Double climbing and diving.

- (3) One overhead target (fig. 30③).

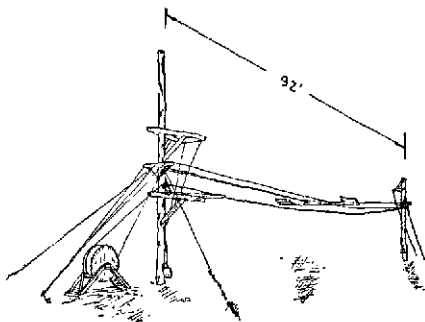

③ Overhead.

FIGURE 30.—Targets.

b. A suggested arrangement of the targets is shown in figure 31.

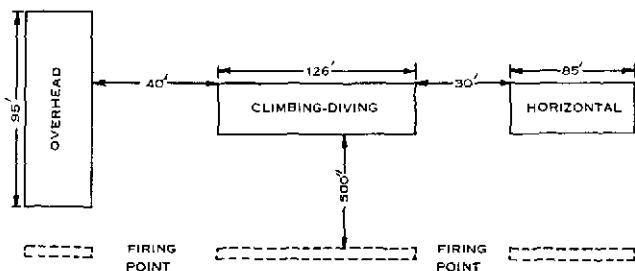

FIGURE 31.—Arrangement of targets.

c. For details of range apparatus see figures 33 to 38, inclusive.

d. (1) The danger area required is dependent upon the type of ammunition. (See AR 750-10 for size and shape.)

(2) The miniature range may be laid out in the same manner as described in paragraph 148c. Care must be taken to insure that the firing line and targets are placed so that no fire will fall outside of the danger area.

e. If the organization for training is as suggested in paragraph 133b, the following equipment is necessary:

- 1 automatic rifle, caliber .30, M1918A2, for each two men firing, or
- 1 caliber .22 rifle for each two men firing.
- 4 aiming and leading targets (fig. 28). (Each of these targets consists of a piece of beaverboard on which the silhouettes are pasted.)
- 6 instruction firing targets per range (fig. 29). (These targets are the same as the aiming and leading targets except that the spotters are eliminated.)
- 1 score card per man.

INDIVIDUAL SCORE CARD  
ANTI-AIRCRAFT RIFLE MARKSMANSHIP

Date \_\_\_\_\_, 19\_\_\_\_

Name \_\_\_\_\_

Target	1 TL lead			2 TL lead			3 TL lead		
	Rounds fired	Hits	Per-cent	Rounds fired	Hits	Per-cent	Rounds fired	Hits	Per-cent
Horizontal									
Climbing									
Diving									
Overhead									
Total									

■ 148. TOWED-TARGET RANGE.—*a.* In selecting the location of a towed-target range the danger area is the chief consideration. (See AR 750-10.)

*b.* The firing point should accommodate at least 50 men in line with a 1½-yard interval between men. A level strip of ground, preferably on a hill, 75 yards long and 2 yards wide is suitable. A firing point similar to the firing point of a known distance rifle range may be built.

*c.* (1) After the towed target range has been selected, the firing point, limits of fire, and danger area should be plotted on a map or sketch of the area.

(2) From this map or sketch the range is then laid out on the ground. First, each end of the firing point is marked by a large stake. The right and left limits of fire are then each marked by a post. Each post is placed at the maximum distance at which it will be plainly visible from the firing point. When these distances have been determined, the posts are located in azimuth by the following method: To locate the post marking the left limit of fire, an aiming circle or other angle-measuring instrument is set up at the right end stake of the firing point. It is then oriented and laid on an azimuth

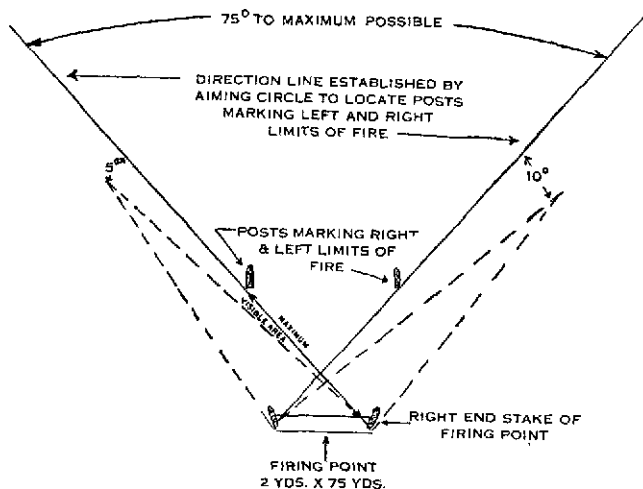

FIGURE 32.—Towed target range showing firing point and limits of fire; dotted lines show danger area.

which, by reference to the map or sketch, is known to be the farthest to the left that the rifle at the right end of the firing point can safely be fired. The post marking the right limit of fire is similarly located with the instrument set up at the left end stake of the firing point. (See fig. 32.)

(3) Direction guides for the towing airplane to follow should, within the limits of fire, be distinctly marked on the ground for each course. White targets or strips of cloth placed flat on the ground about 30 feet apart are suitable

■ 149. TOWED TARGETS.—*a. Type and source.*—The targets used in towed target firing are sleeve targets furnished by the Air Corps unit assigned the towing mission. They are returned to the Air Corps unit after they have been scored.

*b. Tow line.*—The towing line will be not less than 600 yards long.

■ 150. INSTRUCTION TO PILOTS FOR TOWING MISSIONS.—*a.* Towed target firing requires the closest cooperation between the pilot of the towing airplane and the officer in charge of

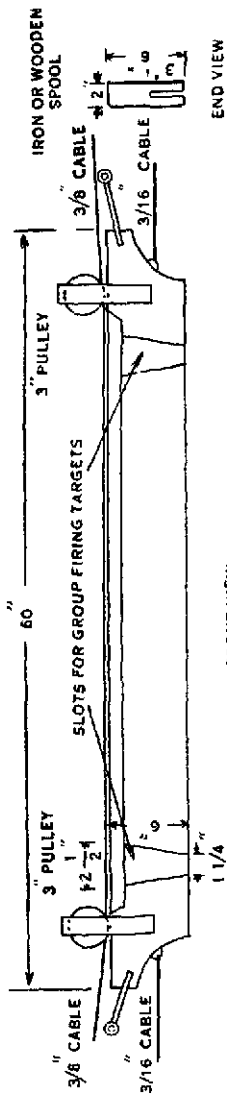

FRONT VIEW

END VIEW

FIGURE 88.—Nonoverhead target carrier.

firing. Decisions affecting the safety of the plane rest with Air Corps personnel.

b. The air mission for towed target firing should be specifically stated. The commanding officer requesting airplanes for towed target firing should furnish, in writing, to the Air Corps unit commander concerned the following information:

(1) Place of firing.

(2) Date and hour of firing.

(3) Number of missions to be flown—altitude, course, speed, and number of runs for each.

(4) Ground signals to be used.

(5) Map of the area with firing line, angle of fire, danger area, course of each mission, and location of grounds for dropping targets and messages all plotted thereon. An alternate dropping ground should be designated when practicable, and either or both dropping grounds are subject to approval by the pilot.

(6) Length of tow line, within limits established by the Air Corps, and subject to approval by the pilot.

(7) Number of sleeve targets required.

c. Whenever practicable, the officer in charge of the firing will discuss with the pilot the detailed arrangements mentioned in *b* above. This discussion should take place on the towed target range where the various range features can be pointed out to the pilot. The courses over which the airplane is to be flown should be distinguished on the ground (within the angle of fire). Machine gun targets placed flat on the ground about 30 feet apart or strips of target cloth are practicable for this purpose on some courses. On others a terrain feature such as a beach line may be used.

■ 151. SIGNALS.—*a.* Direct radio communication is the most effective means by which the officer in charge of towed target firing and the pilot of the towing plane maintain contact with each other. Even though radio is being used, panels should be available in case radio communication fails.

*b.* For signaling from the ground to the pilot, any method agreed upon may be used. The panel signals generally used are as follows:



Stand by.....	0 0 2
Ready to fire.....	0 0 0
Repeat run No. 1.....	0 9 1
Repeat run No. 2.....	0 9 2
Repeat run No. 3.....	0 9 3
Repeat course.....	0 9 4
Mission complete.....	Panels are picked up

c. The pilot may also communicate with the officer in charge of firing by dropped messages or by rocking his wings.

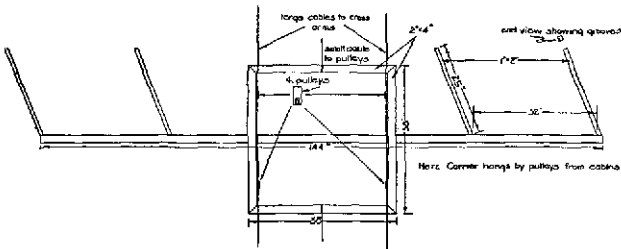

FIGURE 34.—Overhead target carrier.

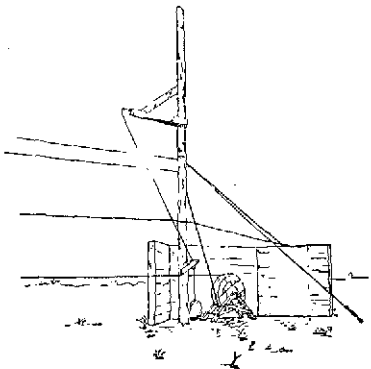

FIGURE 35.—Rear view of nonoverhead range butts, showing drum, guide wires, and bumper.

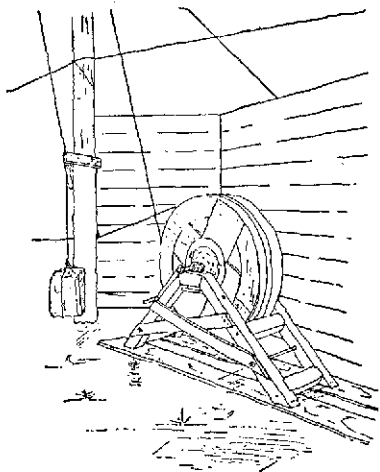

FIGURE 36.—Moving target drum (one complete turn moves target 15 feet).

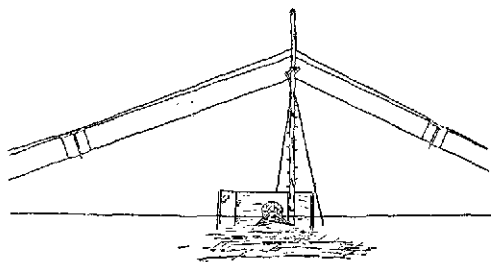

FIGURE 37.—Climbing and diving target (rear view).

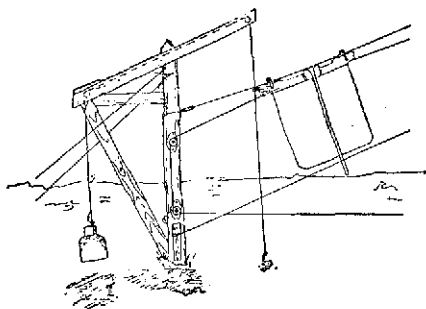

FIGURE 38.—Climbing and diving target (rear view) and method of securing target to frame.

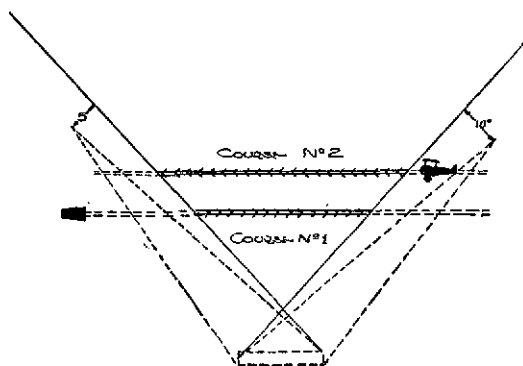

FIGURE 39.—Courses Nos. 1 and 2. (Firing takes place when target is on shaded portion of course.)

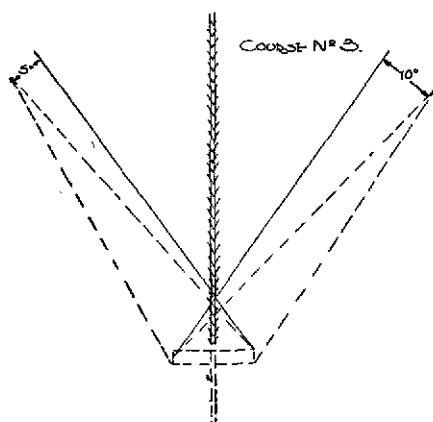

FIGURE 40.—Course No. 3. (Firing takes place when target is on shaded portion of course. Fire is opened when towing airplane is 50 yards or less from firing point.)

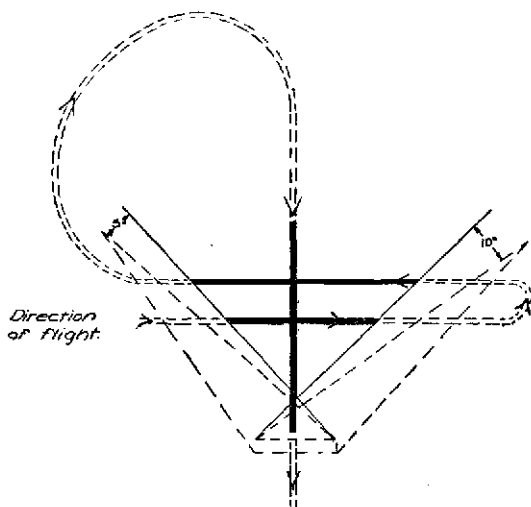

FIGURE 41.—Course No. 4. (Heavy lines indicate when towed target is fired upon.)

## CHAPTER 5

### TECHNIQUE OF FIRE

	Paragraphs
SECTION I. General .....	152-154
II. Range estimation .....	155-159
III. Target designation .....	160-166
IV. Automatic rifle fire and its effect .....	167-174
V. Application of fire .....	175-182
VI. Landscape target firing .....	183-190
VII. Field target firing .....	191-196

#### SECTION I

#### GENERAL

■ 152. **DEFINITIONS.**—*a.* Technique of fire is the application and control of collective fire. Instruction in the technique of fire is given to automatic riflemen after they have completed or progressed sufficiently in other allied subjects such as known distance marksmanship, extended order, drill and combat signals, and certain elements of scouting and patrolling. This chapter deals with instruction in the technique of fire. While the application of this training to combat should be kept in mind it does not include the solution of tactical exercises.

*b.* Collective fire is the combined fire of a group of individuals. It may include the fire of several different weapons.

*c.* A fire unit is one whose fire in battle is under the immediate and effective control of its leader. The automatic rifle fire unit is usually the squad or team.

■ 153. **IMPORTANCE OF RIFLE FIRE**—Effective rifle fire is a characteristic of successful Infantry and is an element which may determine the issue of battle. Collective fire is most effective when it is the product of teamwork.

■ 154. **SCOPE.**—Instruction is progressive and is divided into six consecutive steps. These are—

Range estimation.

Target designation.

Automatic rifle fire and its effect.

Application of fire.  
Landscape target firing.  
Field target firing.

## SECTION II

## RANGE ESTIMATION

■ 155. IMPORTANCE.—*a.* The battle sight for the automatic rifle, caliber .30, M1918A2, corresponds to a sight setting of approximately 300 yards. With the use of the battle sight a shot will strike the target with the following approximate relation to the point of aim with respect to elevation:

Range:

<i>Yards</i>	<i>Strike with use of battle sight</i>
600-----	78 inches below point of aim.
500-----	40 inches below point of aim.
400-----	14 inches below point of aim.
300-----	0 strikes the point of aim.
200-----	6 inches above point of aim.
100-----	5.5 inches above point of aim.

*b.* It is therefore important for the leader or individual soldier to be able to estimate the range to the target in any circumstances and to decide whether the battle sight or a more exact setting will be used.

■ 156. METHODS.—The following methods of estimating ranges are considered in instruction in the technique of automatic rifle fire:

Use of tracer bullets.  
Observation of fire.  
Estimation by eye.

■ 157. USE OF TRACER BULLETS.—The estimator fires a tracer bullet with his sight set at the estimated range. He then corrects the sight setting according to the strike of the bullet and continues the process until a tracer appears to strike the target. The estimator then announces the correct range making allowance for the zero of his own rifle.

■ 158. OBSERVATION OF FIRE.—This method can be used with ordinary ball cartridges when the ground is dry and the strike

of the bullet can be seen. The same procedure is followed as in determining the range by tracer bullets.

■ 159. ESTIMATION BY EYE.—*a. Necessity for training.*—The usual method of estimating ranges in combat is estimation by eye. Untrained men make an average error of 15 percent of the range when estimating by eye. Hence a definite system of range estimation coupled with frequent practice on varied terrain is essential to success with this method.

*b. Unit of measure method.*—(1) Range less than 500 yards are measured by applying a mental unit of measure 100 yards long. Thorough familiarity with the 100-yard unit and with its appearance on varied terrain and at different distances is necessary if the soldier is to apply it accurately.

(2) Ranges greater than 500 yards are estimated by selecting a point halfway to the target, applying the unit of measure to this halfway point, and doubling the result.

(3) The average of a number of estimates by different men will generally be more accurate than a single estimate. This variation of the suggested method is used when time permits, by taking the average of the estimates of members of the squad or group or of specially qualified men.

*c. Appearance of objects.*—If much of the ground between the observer and the target is hidden from view, the application of the unit of measure is impracticable. In such cases the range is estimated by the appearance of objects. Whenever the appearance of objects is used as a basis for range estimation, the observer must make allowances for the following effects:

(1) Objects seem nearer—

(a) When the object is in a bright light.

(b) When the color of the object contrasts sharply with the color of the background.

(c) When looking over water, snow, or a uniform surface like a wheat field.

(d) When looking downward from a height.

(e) In the clear atmosphere of high altitudes.

(f) When looking over a depression, most of which is hidden.

(2) Objects seem more distant—

(a) When looking over a depression, most of which is visible.

(b) When there is a poor light or fog.

(c) When only a small part of the object can be seen.

(d) When looking from low ground upward toward higher ground.

*d. Exercises.*—(1) *No. 1.*—(a) *Purpose.*—To familiarize the soldier with the 100-yard unit of measure.

(b) *Method.*—Units of measure, 100 yards each, are staked out on varied ground, using markers that will be visible up to 500 yards. The men are required to become thoroughly familiar with the appearance of each unit of measure from the prone, kneeling, and standing positions at various ranges.

(2) *No. 2.*—(a) *Purpose.*—To illustrate the application of the unit of measure.

(b) *Method.*

1. Ranges up to 900 yards are measured accurately and marked at every 100 yards by large markers or target frames, each bearing a number to indicate its range. Men undergoing instruction are then placed about 25 yards to one side of the prolonged line of markers and directed to place a hat or other object before their eyes so as to exclude from view all of the markers. They are then directed to apply the unit of measure five times along a straight line parallel to the line of markers. When they have selected the final point, the eye cover is removed and the estimations of the successive 100-yard points and the final point are checked against the markers. Accuracy is gained by repeating the exercise.

2. Ranges greater than 500 yards are then considered. With the markers concealed from view, men estimate the ranges to points which are obviously over 500 yards distant and a little to one side of the line of markers. As soon as they have announced each range they remove their eye covers and check the range to the target and to the halfway point by means of the markers.



Prone, sitting or kneeling, and standing positions are used during this exercise.

(3) *No. 3.*—(a) *Purpose.*—To give practice in range estimation.

(b) *Method.*—From a suitable point, ranges are previously measured to objects within 1,000 yards. The men are required to estimate the ranges to the various objects as they are pointed out by the instructor, writing down their estimates on paper pads or slips. At least one-half of the estimates are made from the prone or sitting positions. Thirty seconds are allowed for each estimate. When all ranges have been estimated the papers are collected and the true ranges announced to the class. To create interest, individual estimates and squad averages may be posted on bulletin boards.

### SECTION III

#### TARGET DESIGNATION

■ 160. **IMPORTANCE.**—Target designation is a vital element in the technique of fire unless the target is self-evident. Battlefield targets are generally so indistinct that leaders and troops must be able to designate their location and extent. Small units and individuals must also be trained to place heavy fire on indistinct or probable targets in appropriate circumstances.

■ 161. **TOPOGRAPHICAL TERMS.**—Prior to instruction in target designation, automatic riflemen should understand the topographical terms normally employed in designating targets; for example, crest, military crest, hill, cut, ridge, bluff, fill, ravine, crossroads, road junction, road center, road fork, skyline.

■ 162. **METHODS.**—a. The following methods are used to designate targets:

Tracer bullets.

Pointing.

Oral description.

b. Troops will be trained in *all* the methods. The method used should be the one best suited to the conditions existing

at the time of the appearance of the target. When methods are equally effective, the simplest will be employed.

■ 163. TRACER BULLETS.—*a.* The use of tracer bullets is a quick and sure method of designating an obscure battlefield target. Their use, however, has limitations for they may disclose the position of the firer to the enemy; further, the effect of a sudden burst of fire is lessened by preceding it with tracers.

*b.* To designate a point target by this method, the individual announces, "Range 500, watch my tracers," and fires a tracer at the target. If the target has width, the flanks are indicated by tracer bullets and announced as "left flank, right flank." Any range correction should be announced.

■ 164. POINTING.—Targets may be pointed out either with the arm or the automatic rifle. Pointing may be supplemented by oral description. To use the automatic rifle for this purpose it is canted to the right and aimed at the target. The head is then straightened up without moving the rifle. A soldier standing behind looks through the sights and locates the target. If time permits, the bipod is adjusted and the rifle is aimed at the target. In pointing, the range is always announced. Usually some supplementary description will be necessary.

■ 165. ORAL DESCRIPTION.—*a. Use.*—Oral description is often used to designate targets. However, battlefield conditions will rarely permit the leader to designate a target directly to all members of his unit by this method. For this reason either pointing or tracers are frequently used in combination with oral description.

*b. Elements of oral target designation.*—The elements of oral target designation are—

Range.

Direction.

Description of target.

These elements are always given in the above sequence with a slight pause between each element. An exception to this rule occurs when the target is expected to be visible for a short time only. In this case the target is pointed out as quickly as possible; for example, such an oral target designa-

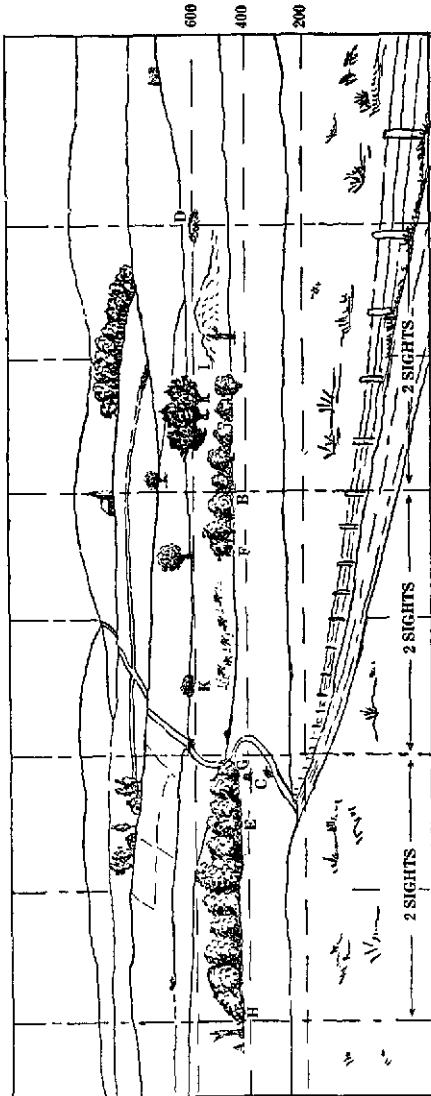

FIGURE 42.

tion might be "Those men." No range is announced and the automatic riflemen open fire with the sight setting then on their automatic rifles (fig. 42, target at K). If time permits, the range is announced and sights are set immediately before looking for the target.

*c. Direction.*—The terms "front" (left, right) and "flank" (left, right) may be used to indicate the general direction of the target. When necessary, the direction is fixed more accurately by the methods hereafter described.

*d. Simple description.*—When the target is plainly visible or at an easily recognized point as illustrated in figure 42, a simple description is used, for example (target at A):

Range: 425.

Left front.

Sniper at base of dead tree.

*e. Reference point.*—When the target is indistinct or invisible and is not located at some prominent point, the direction of the target is indicated by the use of a reference point. This is an object, preferably a prominent one, by reference to which the location of other points may be determined. In selecting a reference point, care must be taken that another similar object is not mistaken for the one intended. A reference point on a line with the target and beyond it will give greater accuracy than one between the observer and the target. For brevity a reference point is called "Reference."

(1) When the reference point is on line with the target, the description takes the following form (target at B):

Range: 450.

Reference: church spire.

Target: machine gun in edge of woods.

It will be noted that the range announced is that to the target and not to the reference point. When the word reference is used the word "target" is also used to differentiate between the two objects. Another example follows (target at C):

Range: 300.

Left front.

Reference: black stump.

Target: sniper on far side of road.

(2) When the reference point is not on line with the target—

(a) It is necessary to indicate the distance to the right or left of the reference point at which the target is located. This distance is measured in units called "sights" (par. 167b). Suppose that the automatic rifle is pointed so that the left edge of the raised sight leaf is on line with the reference point and it is found that the right edge of the sight leaf is in line with the target, the target is then one sight width to the right of the reference point and it is announced as "Right, one sight." If the sight can be applied one and one-half times in the above manner, the target is "Right, one and one-half sights." The following examples illustrate this method:

(Target at D)—

Range: 600.

Reference: church spire; right, two sights.

Target: group of enemy in shellhole near crest.

(Target at E)—

Range: 425.

Left front.

Reference: dead tree; right one and one-half sights.

Target: sniper in edge of woods.

(Target at F)—

Range: 450.

Reference: church spire; left one-half sight.

Target: machine gun in corner of woods.

(b) The width or extent of targets is also measured in sights (target G to H).

Range: 425.

Reference: church spire; left two sights.

Target: enemy groups in edge of woods extending left two sights.

(3) Successive reference points may be used instead of sight measurements from one reference point (target at I). The following example illustrates this method:

Range: 500.

Reference: church spire; to the right and at a shorter range, group of three trees; to the right and at the same range.

Target: machine gun at left end of mound of earth.

(4) An example of a combination of successive reference points and sights is as follows (target at K):

Range: 600.

Reference: church spire; to the left and at a shorter range, lone tree; left one sight and at the same range.

Target: machine gun in clump of brush.

*f. Variations.*—If one end of a linear target is considerably nearer than the other, the average range is announced, since dispersion will cover the target. In oral description the simplest, briefest, and clearest description that fits the conditions is the most effective. Informal or conversational descriptions may be used to supplement the more formal descriptions when the target is not recognized from the latter alone.

■ 166. EXERCISES.—*a. No. 1.*—(1) *Purpose.*—To afford practice in target designation by means of tracer bullets.

(2) *Method.*—(a) On a known distance or field firing range a concealed target representing a machine gun is placed near a pit or other bulletproof shelter. About 500 yards in front of the target a firing position suitable for a squad is selected. The location of the target should be visible from the firing position, but the target itself is carefully concealed.

(b) The squad is deployed along the firing position and all except the leader are then faced to the rear.

(c) The leader takes the prone position and is told that the waving of a red flag to his front will represent the firing and smoke from the machine gun.

(d) A man stationed in the pit waves a flag in front of the target for about 30 seconds and retires to the protection of the pit.

(e) The squad is faced to the front and men take the prone position. Automatic rifles are loaded, the leader using tracer ammunition and the automatic riflemen ball cartridges.

(f) The leader points out the target by firing tracers and announces the range.

(g) As soon as each automatic rifleman understands the location of the target he opens fire with the proper sight setting.

(h) Shortly after both automatic riflemen have taken up the firing, the instructor terminates the exercise.

(i) The squad leader after designating the target observes the firing. The second in command assists the squad leader.

(j) After firing ceases, sight settings are checked by the squad leader and the target is examined or the hits are signaled to the squad.

*b. No. 2.—(1) Purpose.*—To teach the use of sights and fingers for lateral measurement.

(2) *Method.*—(a) A number of short vertical lines 1 foot apart are plainly marked on a wall or other vertical surface. At a distance of 20 feet from the wall a testing line is drawn or marked out by stakes. The instructor explains that the vertical lines are one sight (50 mils) apart when measured from the testing line, so that the correct distance from the automatic rifle sight leaf to the eye can be determined by pointing the automatic rifle at the vertical lines and moving the eye along the stock until the raised sight leaf covers the space between one of the vertical lines and the next line to the right or left. The instructor demonstrates with a rifle while explaining.

(b) The men take positions on the testing line and each determines the proper distance of his eye from the sight as explained by the instructors. The position of the eye with reference to the stock is carefully noted or marked on the stock.

(c) The instructor then explains and demonstrates the use of fingers in measuring sights. First he holds his hand, with palm to rear and fingers pointing upward, at such distance from his eye that each finger will measure one sight on the wall. Then he lowers his hand to his side without changing the angle of the wrist or elbow and notes the exact point at which the hand strikes the body. Thereafter when measuring with the fingers he first places his hand at this point and raises his arm to the front without changing the angle of the wrist or elbow. His hand will then be in the correct position for measuring sights by fingers. The men then determine the proper distance of fingers from the eye as explained by the instructor.

(d) Practice in lateral measurement is given, using convenient objects within view and using both sights and fingers.

c. No. 3.—(1) *Purpose*.—To afford practice in target designation by pointing with the rifle.

(2) *Method*.—(a) The squad is formed faced to the rear. The instructor then points out the target to the squad leader who takes the kneeling or prone position, estimates the range, adjusts his sight, alines his sight on the target, and then calls "Ready."

(b) The members of the squad then move in turn to a position directly behind the squad leader and look through the sights until they have located the target. The range is given orally by the squad leader to each automatic rifleman.

(c) As soon as each automatic rifleman has located the target he moves to the right or left of the squad leader, sets his sight, adjusts his bipod, and alines his sights on the target.

(d) The instructor, assisted by the squad leader, verifies the sight setting and the alinement of the sights of each rifle.

d. No. 4.—(1) *Purpose*.—To afford practice in target designation by oral description.

(2) *Method*.—(a) The squad is deployed faced to the rear. The squad leader is at the firing point where the automatic rifles with bipod rests adjusted have been placed.

(b) At a prearranged signal the target is indicated by the display of a flag. When the squad leader states that he understands the position of the target the flag is withdrawn.

(c) The squad is then brought to the firing point, placed in the prone position, and each automatic rifleman required to set his sight, using the bipod rest, and sight his rifle on the target according to the oral description of the squad leader. The squad leader gives his target designation from the prone position.

(d) The squad leader's designation is checked from the ground. The automatic riflemen are required to place a support under and brace the butt of their automatic rifle and leave them properly pointed until checked by the instructor or squad leader.



## SECTION IV

## AUTOMATIC RIFLE FIRE AND ITS EFFECT

■ 167. NATURE OF TRAJECTORY.—The trajectory is the path followed by a bullet in its flight through the air. The bullet leaves the rifle at a speed of 2,700 feet per second. Because of this great speed, the trajectory at short ranges is almost straight or flat.

■ 168. DANGER SPACE.—The space between the automatic rifle and the target in which the trajectory does not rise above a man of average height is called the "danger space." The trajectory for a range of 700 yards does not rise above 68 inches. Therefore, it is said that the danger space for that range is continuous between the muzzle of the gun and the target. For ranges greater than 700 yards the bullet rises above the height of a man standing, so that only parts of the space between the gun and the target are danger spaces (fig. 43).

■ 169. DISPERSION.—Because of differences in ammunition, aiming, holding, and wind effects, a number of bullets fired from an automatic rifle at a target are subject to slight dispersion. The trajectories of those bullets form an imaginary cone-shaped figure called the "cone of dispersion."

■ 170. SHOT GROUPS.—When the cone of dispersion strikes a vertical target it forms a pattern called a "vertical shot group." A shot group formed on a horizontal target is called a "horizontal shot group." Due to the flatness of the trajectory, horizontal shot groups on level ground vary in length from 100 to 400 yards depending upon the range.

■ 171. BEATEN ZONE.—The beaten zone is the area on the ground struck by the bullet forming a cone of dispersion. When the ground is level, the beaten zone is also a horizontal shot group. The slope of the ground has great effect on the shape and size of the beaten zone. Rising ground shortens the beaten zone. Ground that slopes downward and in the approximate curve of the trajectories will greatly lengthen the beaten zone. Falling ground with greater slope than the trajectory will escape fire and is said to be in defilade.

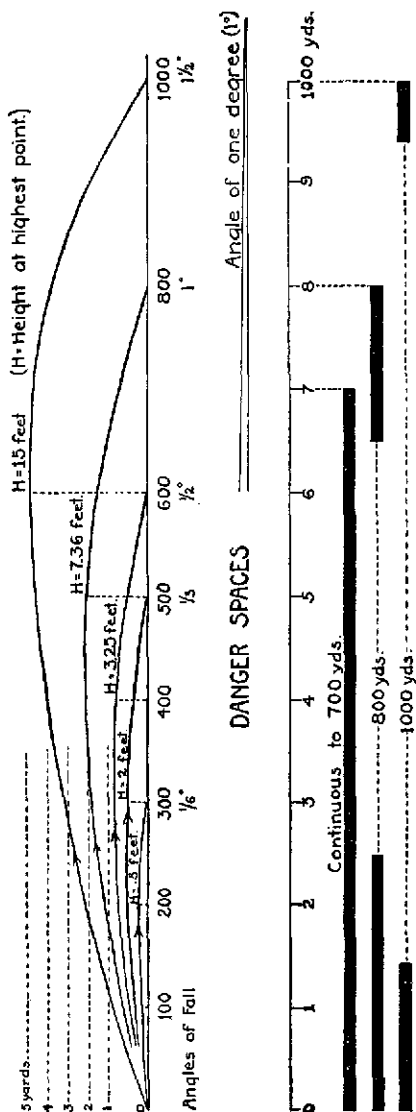

FIGURE 43.—Trajectory diagram (vertical scale is 20 times horizontal scale).

■ 172. CLASSES OF FIRE.—*a.* Fire as regards direction is classified as follows:

(1) *Frontal*.—Fire delivered on the enemy from its front.

(2) *Flanking*.—Fire delivered on the enemy from its flank.

*b.* Fire as regards trajectory is classified as follows:

(1) *Grazing*.—Fire approximately parallel to the ground and close enough thereto to strike an object of a given height. The average height of a man (68 inches) is usually taken as determining grazing fire.

(2) *Plunging*.—Plunging fire is fire in which the angle of fall of the bullets with reference to the slope of the ground is such that the danger space is practically confined to the beaten zone and the length of the beaten zone is materially lessened. Fires delivered from high ground on ground lying approximately at right angles to the cone of fire, or against ground rising abruptly to the front with respect to the position of the rifle, are examples of plunging fire. As the range increases, fire becomes increasingly plunging because the angle of fall of the bullets becomes greater.

(3) *Overhead*.—Fire delivered over the heads of friendly troops.

*c. Comparison*.—Flanking fire is more effective than frontal fire. Grazing fire is more effective than plunging fire, because the beaten zone is much longer. Overhead fire with the automatic rifle is unusual and may be employed only when the ground affords protection to the friendly troops.

■ 173. EFFECT OF FIRE.—The fire of automatic riflemen armed with the automatic rifle, caliber .30, M1918A2, will generally be opened as close to the enemy as possible. Such fire, properly applied, is of decisive effect. It will also be used against low-flying planes and against mechanized attacks. The effect of fire on such targets is covered in chapters 3 and 4.

■ 174. DEMONSTRATION OF TRAJECTORIES.—*a. Purpose*.—To show trajectories.

*b. Method*.—The unit under instruction watches the firing of a few tracer bullets at targets whose ranges are announced. Ranges of 300, 600, and 800 yards are suitable selections. The flatness of the trajectories is called to the attention of the men.

## SECTION V

## APPLICATION OF FIRE

■ 175. GENERAL.—*a. Means of action.*—Infantry has two general means of action, fire and movement. Infantry fights by combining these two means of action. Fire and movement are combined in the combat action of the squad and large units. The application of fire by such units is essential to their success.

*b. Application of fire.*—(1) *In the attack.*—The automatic rifleman must be trained to place a large volume of accurate fire upon probable enemy locations and indistinct or concealed targets such as enemy machine guns or small groups. He must be trained to apply such fire quickly upon the order or signal of his leader and in appropriate circumstances to apply it without such order.

(2) *In the defense.*—In defense the fire of automatic riflemen is delivered from positions which must be held. They are placed to secure good fields of fire covering probable avenues of approach and to take advantage of cover and concealment.

*c. Requirements of position.*—In the occupation of a firing position, the location of squads or teams armed with the Browning automatic rifle, caliber .30, M1918A2, in the platoon area should be made with due regard to the following requirements:

(1) Good field of fire covering probable avenues of approach.

(2) Use of cover and concealment.

(3) An indefinite and inconspicuous formation which will suit the terrain and be hard to see.

(4) Control of fire by unit leader.

■ 176. CONCENTRATED AND DISTRIBUTED FIRE.—The size and nature of the target presented may call for the firepower of the entire squad or only a part. The fire of a group must necessarily be either concentrated or distributed fire.

*a. Concentrated fire.*—Concentrated fire is fire directed at a single point. This fire has great effect but only at a single point. Antitank guns and automatic weapons are examples of suitable targets for concentrated fire.

*b. Distributed fire.*—(1) Distributed fire is fire distributed in width for the purpose of keeping all parts of the target under effective fire. It is habitually used on targets having any considerable width such as a portion of the edge of a woods or road.

(2) Unless otherwise instructed the automatic rifleman will habitually cover the entire target, employing bursts of about five rounds at the slow cyclic rate. The first burst is fired on that portion of the target corresponding generally to the automatic rifleman's position in the squad or group.

(3) If other targets appear, the squad or team leader announces such changes in the fire distribution as are necessary.

■ 177. ASSAULT FIRE.—Assault fire is that automatic fire delivered by the automatic rifleman while advancing at a walk, the rifle being carried as prescribed in paragraph 62.

■ 178. RATE OF FIRE.—The automatic rifleman fires at the rate of fire most effective under existing conditions and generally at a rate of from 120 to 150 shots per minute automatic fire.

■ 179. FIRE DISCIPLINE.—Fire discipline in the automatic rifle squad implies the careful observance of the instructions relative to the use of the automatic rifle in combat and exact execution of the orders of the squad leader. It implies care in sight setting, aim, trigger manipulation, close attention to the leader, independent increase in the rate of fire when the target becomes more favorable, cessation of fire on the squad or team leader's order or signal, or when a target cannot be located with sufficient definition to justify the expenditure of ammunition. It also implies that when the squad or team leader has released the automatic rifleman from the control of his fire order, each automatic rifleman acts on his own initiative, selects sight setting and target independently, and opens and ceases fire in accordance with the situation.

■ 180. FIRE CONTROL.—*a. General.*—Fire control consists of the initiation and supervision of the fire of the automatic rifle squad or team by its leader. By initiating fire on order or signal, the effect of surprise is increased. On the other hand, the irregular formation adopted for an advance will often render such action impracticable. In such case fire

must be opened and maintained on the initiative of automatic riflemen as circumstances require. In any case the leader of the automatic rifle squad or team must supervise and seek to control the fire of his men so that it is directed and maintained at suitable targets. All must understand that controlled fire is always the most effective.

*b. How exercised.*—(1) Squad leaders, assisted by their assistant squad leaders, exercise fire control by means of orders, commands, and signals. The signals most frequently used are—

Signals for range.

Commence firing.

Fire faster.

Fire slower.

Cease firing.

Are you ready?

I am ready.

(2) A description of the signals is found in FM 22-5.

■ 181. FIRE ORDERS.—*a. Purpose.*—The leader of an automatic rifle squad or team having made a decision to fire on a target must give certain instruction as to how the target is to be engaged. The instructions by which the fire of a squad or team is directed and controlled form the fire order.

*b. Basic elements.*—A fire order contains three basic elements which are announced or implied in every case. Only such elements or parts thereof will be included as are essential. The sequence is always as follows:

Target designation element.

Fire distribution element.

Fire control element.

(1) *Target designation element.*—The target may be designated by any one or a combination of the prescribed methods (see sec. III).

(2) *Fire distribution element.*—The fire distribution element is normally omitted from the fire order for automatic rifle units. The method of fire distribution described in paragraph 176*b* is habitually employed. When necessary, the fire distribution element includes the subdivision of the target. For example—

(a) A squad leader desires to engage two machine gun nests; the distribution element of his order might be as indicated by the italic words below:

Range: 500.

Front.

Machine gun at base of lone pine.

*Cooper, your target.*

Range: 500.

Left flank.

Machine gun at base of haystack.

*Brown, your target.*

(b) The squad leader may engage two targets by placing one automatic rifleman under the command of the assistant squad leader and directing him to engage one target, while he engages the other target with the other automatic rifleman.

(3) *Fire control element.*—The fire control element normally consists initially of merely the command or signal COMMENCE FIRING. It may include the number of magazines or rounds. Other fire control elements are—

AT MY SIGNAL (followed by hand signal).

ONE MAGAZINE (FIVE ROUNDS) COMMENCE FIRING.

c. *Example.*—An example of a complete fire order follows:

(1) *Target designation element.*

(Range) \_\_\_\_\_ Range: 600.

(Direction) \_\_\_\_\_ Reference: right edge of lone building.

(Description of target) \_\_ Target: group of enemy along hedge.

(2) *Fire distribution element.*—(Implied).

(3) *Fire control element.*—COMMENCE FIRING.

■ 182. DUTIES OF LEADERS.—The following summary of duties of leaders relates only to their duties in the technique of fire:

a. *Squad leader.*—(1) Carries out orders of platoon leader.

(2) Selects firing positions for squad.

(3) Designates targets and issues fire orders.

(4) Controls fire of squad.

- (5) Maintains fire discipline.
- (6) Observes targets and effect of fire.

*b. Assistant squad leader.*—(1) Carries out orders of squad leader.

- (2) Assists squad leader to maintain fire discipline.
- (3) Assumes command of squad in absence of squad leader.
- (4) Participates in firing when the fire of his rifle is considered more important than other assistance to the squad leader.

## SECTION VI

### LANDSCAPE TARGET FIRING

■ 183. SCOPE AND IMPORTANCE.—*a.* After satisfactory progress has been made in the preceding steps, the automatic rifleman may be given practice in the application of those lessons by firing at landscape targets.

*b.* The advantages of this training are—

- (1) The close supervision over all members of the firing group made possible by their close proximity.
- (2) The accessibility and nature of the targets which permit the application and effect of the fire to be readily shown.
- (3) It is a form of instruction which lends itself to indoor training when lack of facilities or weather conditions make it desirable or necessary.

*c.* In circumstances where there is a choice between landscape target firing as covered in this section and firing at field targets as covered in section VII, the latter is to be preferred.

■ 184. DESCRIPTION OF TARGET.—A landscape target is a panoramic picture of a landscape and is of such size that all or nearly all of the salient features will be recognizable at a distance of 1,000 inches. The standard target is the series A target of five sheets in black and white.

■ 185. WEAPONS TO BE USED.—Firing at landscape targets should be with caliber .22 rifles, preferably the M1922M2 equipped with the Lyman receiver sight. When a sufficient number of those rifles are not available, the automatic rifle, caliber .30, M1918A2, may be used.



■ 186. PREPARATION OF TARGETS.—*a. Mounting.*—(1) The sheets are mounted on frames made of 1- by 2-inch dressed lumber with knee braces at the corners. The frames for the target sheets are 24 by 60 inches. These frames are covered with target cloth which is tacked to the edges.

(2) The target sheets are mounted as follows: Dampen the cloth with a thin coat of flour paste and let it dry for about an hour; apply a coat of paste similarly to the back of the paper sheet and let it dry about an hour; apply a second coat of paste to the back of the paper and mount it on the cloth; smooth out wrinkles, using a wet brush or sponge, and work from the center to the edges. The frame must be placed on some surface which will prevent the cloth from sagging when the paper is pressed on it. A form for this purpose can easily be constructed. It must be of the same thickness as the lumber from which the frames are built, and must have approximately the same dimensions as the aperture of the target frame.

*b. Supports for target frames.*—The target frames described above are set on posts placed upright in the ground 5 feet from center to center. The target frames are supported on the posts by cleats and dowels in order to allow for easy removal.

*c. Range indicators.*—In order to make all elements of target designation complete, assumed ranges must be used as landscape targets. Small cards on which are painted appropriate numbers representing yards of range are tacked along one or both edges of a series of panels. The firers must be cautioned that the range announced in any target designation is for the sole purpose of designating the target, and that the sight setting necessary to zero their rifles must not be changed.

*d. Direction cards.*—In order to provide the direction element in oral target designation, small cards on which are painted "front, right front, left front, right flank, left flank" are tacked above the appropriate panels of the landscape series.

*e. Scoring devices.*—(1) A squad or team may be brought up to the target and there view the results of its firing. Scoring

the exercises will tend to create competition between squads and will enable the instructor to grade their relative proficiency in this form of training. A scoring device, conforming in size to the 50 and 75 percent shot groups to be expected of average shots firing at 1,000 inches, and at reduced ranges, can easily be made from wire, or a better one may be prepared by imprinting a scoring diagram on a sheet of transparent celluloid. The scoring space is outlined on the target in pencil before the target is shown to squad leaders. This procedure prevents any misunderstanding of squad leaders as to the limits of the designated target. Upon completion of firing, the entire squad is shown the target and the results of the firing.

(2) While shot groups are in the form of a vertical ellipse, the 50- and 75-percent zones should be shown by the devices as rectangles. This is for convenience in their preparation. For a distance of 1,000 inches, the 50-percent zone is a rectangle  $2\frac{1}{2}$  inches high by 2 inches wide; the 75-percent rectangle is 5 inches high by 4 inches wide. For a distance of 50 feet, the 50-percent zone is a rectangle  $1\frac{1}{2}$  inches high by 1.2 inches wide; the 75-percent rectangle is 3 inches high by 2.4 inches wide. The target is at the center of the inner rectangle or 50-percent zone.

(3) For a linear target, such as a small area over which the automatic riflemen will distribute their fire, the 50-percent zone is formed by two lines drawn parallel to the longer axis of the target (area) and with the target midway between those lines. For a distance of 1,000 inches the lines should be  $2\frac{1}{2}$  inches apart; for a distance of 50 feet the lines should be  $1\frac{1}{2}$  inches apart. Two additional lines similarly drawn form the 75-percent zone. For a distance of 1,000 inches the lines should be 5 inches apart; for a distance of 50 feet the lines should be 3 inches apart. The width of the zones will vary according to the size of the target selected. For a distance of 1,000 inches the zones extend 1 inch beyond each end of the target; for a distance of 50 feet the zones extend .6 inch beyond each end of the target. The zones are then divided into a convenient number of equal parts, the number depending on the length (width) of the target and the num-

ber of men firing. This is done in order to give a score for distribution of shots fired on a linear target (par. 189b).

■ 187. ZEROING-IN OF RIFLES.—*a.* It will be necessary to zero-in the rifles used before firing exercises on the landscape target. A blank target with a row of ten 1-inch square black pasters about 6 inches from and parallel with the bottom edge of the target should be prepared and used for this purpose. In all firing for zeroing-in, sandbag rests are used.

*b.* The procedure for zeroing-in the U. S. rifle, caliber .22, M1922, M1922M1 and M2, in detail is as follows:

(1) The sights of the rifle are blackened.

(2) The squad is deployed on the firing points; the squad leader takes the proper position in rear of the squad.

(3) The instructor causes each firer to set his sights at zero elevation and zero windage and checks each sight.

(4) Each man is assigned the particular small black paster which corresponds to his position in the squad as his aiming point.

(5) Three rounds are issued to each man on the firing point to be loaded and fired singly at the command of the instructor.

(6) Each man fires three shots at his spotter at the command **THREE ROUNDS, COMMENCE FIRING.**

(7) The instructor commands: **CLEAR RIFLES.** The squad leader checks to see that this is done.

(8) The instructor and squad leader inspect the target and based upon the location of the center of impact of the resultant shot group give each man the necessary correction for his next shot, as "Up 1 minute, right one-half point."

(9) The firing continues as outlined above until all rifles are zeroed in, that is, until each man has hit his aiming point.

*c.* For a caliber .22 rifle with the Lyman receiver sight, at a distance of 1,000 inches, a change of 5 minutes in elevation will move the strike of the bullet about 1½ inches. A change of one point of windage moves the strike about 1¼ inches. At a distance of 50 feet a change of 6 minutes in elevation will move the strike of the bullet about 1 inch, and a change of one point of windage, about ¾ inch.

d. To zero the automatic rifle, caliber .30, M1918A2, at 1,000 inches, see paragraph 82.

■ 188. FIRING PROCEDURE.—The sequence of events in conducting firing exercises is as follows:

a. All members of the squad except the squad leader face to the rear.

b. The instructor takes the squad leader to the panels and points out the target to him.

c. They return to the firing point; the squad leader takes charge of the squad and causes the men to resume their firing positions.

d. The squad leader gives the command **LOAD**, cautioning, “— rounds.”

e. The squad leader designates the target orally. Reference to panels to indicate direction should not be allowed in the designation. To complete the fire order, the squad leader adds: **COMMENCE FIRING**.

f. When the squad has completed firing, the squad leader commands: **CEASE FIRING, CLEAR RIFLES**. The squad then examines the target. The target panel is scored and marked with the squad number.

g. The instructor holds a short critique after each exercise.

■ 189. SCORING.—a. *Concentrated fire*.—In concentrated fire the sum of the value of the hits within the two zones is the score for the exercise. For convenience of scoring and comparison, 100 is fixed as the maximum score. Any method of scoring and of distribution of ammunition among members of the squad may be used. The following examples based on firing 50 rounds are given as suggested methods:

(1) Value of each hit in 50-percent zone, 2.

(2) Value of each hit in 75-percent zone, 1.

b. *Distributed fire*.—A method of scoring for distributed fire of the squad on a target of width is as follows:

(1) Value of each hit in 50-percent zone, 2.

(2) Value of each hit in 75-percent zone, 1.

(3) Value of each distribution space (if target is divided into 10 equal spaces), 10.

(4) The score for distribution, plus the value of all hits, divided by two is the score for the exercise.

■ 190. EXERCISES.—The fire of the automatic rifleman, when armed with the Browning automatic rifle, caliber .30, M1918A2, will be employed against targets on the landscape target appropriate to automatic rifle fire.

a. No. 1.—(1) *Purpose*.—To teach target designation and to show the effect of concentrated fire.

(2) *Method*.—The squad leader employs the fire of his squad at one point target indicated to him by the instructor.

b. No. 2.—(1) *Purpose*.—To teach target designation and the division of fire on two points of concentration.

(2) *Method*.—The instructor indicates two point targets to the squad leader giving the nature of each. The squad leader applies the fire of one of his automatic riflemen on one target, and the fire of the other automatic rifleman on the other. The scoring will be as for concentrated fire in each target, the several scores being combined in totals for the score for the exercises.

c. No. 3.—(1) *Purpose*.—To teach target designation and fire control in diverting part of the fire of the automatic rifle squad to a suddenly appearing target.

(2) *Method*.—The instructor indicates a point target to the squad leader. After firing has commenced, the instructor indicates and gives the nature of a new target to a flank. The squad leader applies the fire of his squad to the first target. When the second target is indicated, he shifts the fire of one of his automatic riflemen, as directed by the instructor, from the first to the second target.

d. No. 4.—(1) *Purpose*.—To teach target designation, fire control, and the method of searching a small area with automatic rifle fire.

(2) *Method*.—The instructor indicates and gives the nature of two point targets. After firing has commenced, the instructor indicates a small area in which an enemy group is under cover. The squad leader applies the fire of his squad on the two point targets. When the area target is indicated, the squad leader is told to shift the fire of an automatic rifleman to that target.

e. No. 5.—(1) *Purpose*.—To teach the application of automatic rifle fire on an enemy group marching in formation, the fire control necessary to obtain fire for surprise effect,

and to show the effect of automatic rifle fire on troops in formation.

(2) *Method.*—The instructor indicates to the squad leader a target that represents a small group of the enemy marching in approach march formation, formation for patrol, or the like; the enemy not being aware of the presence of the squad. The squad leader applies the fire of his squad; his instructions must result in the simultaneous opening of fire of both automatic rifles and the distribution of fire over the entire target. The assignment of one of his automatic riflemen to fire at the rear half of the target, and the other automatic rifleman at the forward half, is a satisfactory method of distributing fire over such target.

## SECTION VII

### FIELD TARGET FIRING

■ 191. *GENERAL.*—The training in this step is similar to that given the soldier in landscape target firing, but with the added feature of firing the Browning automatic rifle, caliber .30, M1918A2, at field targets at unknown ranges, the use of cover, fire control under more usual conditions, and range estimation. In order to make this training progressive, the automatic rifleman is first given an opportunity to fire at partially exposed field targets of unknown ranges. As a final stage in this instruction he will be required to fire at some targets which are concealed from view but exposed to fire. Individuals preferably receive this training in the squad or in the team.

■ 192. *SCOPE OF TRAINING.*—*a. Progressive training.*—The inclusion of the training in moving from an approach march formation or place of concealment to firing positions is primarily to teach the automatic rifleman the proper use of cover and selection of firing positions and to connect up the technique of applying and controlling collective fire with other prerequisite allied subjects.

*b. Firing positions and representation of enemy.*—In battle a unit is not deployed with individuals abreast and at regular intervals apart. The selection of individual and team positions is governed by the field of fire, cover, or concealment

while firing, cover of approach to those positions, fire control, and the nature of targets. The representation of the enemy will conform to irregular battle formations. Safety precautions necessary in firing at field targets are given in paragraph 193.

*c. Use of cover.*—(1) The individual use of cover and concealment is taught in FM 7-6. In training in firing at field targets the fundamentals are the same.

(2) In seeking cover in a firing position men may move a few yards in any direction, but they must not be allowed to bunch together behind concealment which does not afford protection from fire. They avoid positions which will mask the fire of others or cause their own fire to be dangerous to other men of their unit.

*d. Marksmanship applied.*—(1) The fundamentals of known distance automatic rifle marksmanship are followed in this training insofar as they are applicable to field conditions.

(2) The fundamentals of known distance marksmanship should be applied to the technique of fire and to combat in a common-sense way. For example, it will often be impracticable to keep the sights blackened, and the soldier is permitted to take advantage of trees, rocks, or any other rest for his weapon which will make his fire more accurate.

*e. Use of battle sight.*—The battle sight corresponds to a sight setting of approximately 300 yards. It is used on targets from 0 to 600 yards when time is lacking for setting the sight or in firing at moving targets.

■ 193. SAFETY PRECAUTIONS.—*a.* In general the safety precautions used on the known distance ranges apply with equal force to instruction in the technique of fire. Safety of personnel is of primary importance in conducting exercises which require the firing of service ammunition. To this end exercises should be drawn to conform to the state of training of the units concerned.

*b.* The officer in charge of an exercise is responsible for the safety of the firing; it is his duty to initiate and enforce such precautions as he deems necessary under existing conditions. No other officer can modify his instructions without assuming the responsibility for the safety of the firing.

c. Before permitting fire to be opened, all men will be on a general line. No man will be permitted to be ahead of or in rear of this line a distance greater than one-half the interval between himself and the man next to him. For example, if the interval between men is 10 paces, then no man will be more than 5 paces ahead of or behind the man next to him.

d. Ball ammunition will not be loaded until each man is in the firing position and the officer in charge has insured that it is safe for each man to fire. Upon completion of firing, the officer in charge will cause all rifles to be unloaded, inspected, and ammunition collected.

e. Upon completion of the day's firing, automatic rifles and belts will be inspected by an officer to insure that no ammunition remains in them.

f. Special precautions will be taken to insure that the range is clear before ammunition is issued.

g. During the firing of exercises automatic rifles will be pointed in the direction of the targets at all times. Special vigilance is required to enforce this rule while men are using a cleaning rod to remove an obstruction from the chamber.

■ 194. SITUATIONS FOR FIRING EXERCISES.—*a.* Each exercise should be initiated by a unit—

(1) Already deployed in a firing position.

(2) Halted in approach march formation or in a place of concealment with observers out.

*b.* In the first case, each automatic rifleman should be in a selected firing position, special attention being paid to individual cover and concealment.

*c.* In the second case, squad leaders select the firing positions for their automatic riflemen; they conduct their squads forward by concealed routes and send the automatic riflemen to their firing positions by individual directions. Occupation of the initial firing position of a unit is done with the minimum of exposure.

■ 195. CRITIQUE.—At the completion of the firing of any exercise the instructor should conduct a critique of that exercise with the firing unit. A suggested form for such a critique is as follows:

*a.* Purpose of the exercise.



b. Approach and occupation of the firing position (individual concealment and cover).

c. Fire order (particular reference being made to the target designation element).

d. Time required to open fire (from the time the leader is told the range is clear).

e. Rate of fire.

f. Fire control.

g. Effect of the fire (upon completion of firing and the range is clear, the targets are scored).

h. Performance of the unit satisfactory or unsatisfactory.

■ 196. SUGGESTED EXERCISES.—*a. No. 1.*—(1) *Purpose.*—Practice in fire orders, application of the fire of a squad in position, fire control, proper individual concealment in the occupation of the firing position.

(2) *Method.*—Enemy represented by one group of targets exposed to fire but partially concealed from view, requiring a simple fire order. Squad leader is shown the targets (personnel with flag) and safety limits for firing position of the squad. When the squad leader fully understands the location and nature of the target and the instructor informs him that the range is clear, he will load ball ammunition, give the fire order, and fire the problem. The range should be estimated by eye and the target designated by oral description.

*b. No. 2.*—(1) *Purpose.*—Practice in fire order, application of the fire of a squad armed with the Browning automatic rifle, caliber .30, M1918A2, on a linear target, fire control, proper deployment and individual concealment in the occupation of the firing position, engagement of a surprise target.

(2) *Method.*—Silhouette targets representing an enemy squad deployed in a firing position are partially concealed from view but exposed to fire. A screen behind the targets is marked with distribution spaces to give squad credit for the shots that did not hit the targets but which would have had an effect on an enemy. Squad is in rear of the firing position; squad leader is shown the linear target (by flag) and then conducts squad forward and disposes it in a concealed firing position. When squad leader is told the range

is clear he will engage the target with surprise fire. A surprise target, well to the flank of the first target, representing an enemy machine gun, appears shortly after the squad has engaged the linear target. The squad leader is told the amount of fire to shift to the surprise target. In addition to the suggested form of critique in paragraph 195, proper distribution of fire on a linear target and the engagement of the surprise target should be discussed.

c. No. 3.—(1) *Purpose*.—Practice in the application of automatic rifle fire over a small area in which an enemy is concealed.

(2) *Method*.—Targets are placed within a small area, exposed to fire but concealed from view. An automatic rifleman is directed to search that area with fire. He distributes his fire throughout the length and breadth of the area.

d. No. 4.—(1) *Purpose*.—Practice in firing at moving targets.

(2) *Method*.—Automatic riflemen fire individually at targets carried on long sticks by men in the pits of a class A range. The men in the pits are each assigned a space, the width of about five regular range target spaces, in which they walk continuously back and forth. By whistle signal, targets are exposed to the firing line for 5 seconds and then concealed for 5 seconds. Targets are exposed once for each shot to be fired. On the firing line one man is assigned to each target. Ranges of 200 or 300 yards are best suited for this class of firing.

## CHAPTER 6

### ADVICE TO INSTRUCTORS

	Paragraphs
SECTION I. General.....	197
II. Mechanical training.....	198-199
III. Marksmanship, known distance targets.....	200-213
IV. Marksmanship, air targets.....	214-218
V. Technique of fire.....	219-226

#### SECTION I

##### GENERAL

■ 197. **PURPOSE.**—The provisions of this chapter are to be accepted as a guide and will not be considered as having the force of regulations. They are particularly applicable to emergency conditions when large bodies of troops are being trained under officers and noncommissioned officers who are not thoroughly familiar with approved training methods.

#### SECTION II

##### MECHANICAL TRAINING

■ 198. **CONDUCT OF TRAINING.**—*a.* As a general rule instruction is so conducted as to insure the uniform progress of the platoon and company.

*b.* The instructor briefly explains the subject to be taken up and demonstrates it himself or with a trained assistant.

*c.* The instructor then causes one man in each squad or subgroup to perform the step while he again explains it.

*d.* The instructor next causes all members of the squads or subgroups to perform the step, checked by their noncommissioned officers. This is continued until all men are proficient in the particular operation, or until those whose progress is slow have been placed under special instructors.

*e.* Subsequent steps are taken up in like manner during the instruction period.

■ 199. **POSITION STOPPAGE SET-UPS.**—*a.* *First position stoppages.*—(1) Place blown primer between lips of magazine and

top cartridge. Let bolt go forward. Replace magazine. Answer: Failure to feed—change magazine.

(2) Place empty cartridge case in chamber. Let bolt go forward—replace magazine. Answer: Insufficient gas—correct gas adjustment.

*b. Second position stoppage.*—Place blown primer on face of bolt or up in locking recess. Let bolt go forward. Replace magazine. Answer: Obstruction—remove blown primer.

*c. Third position stoppage.*—Cock rifle, then place ruptured case in chamber. Replace magazine. Let bolt go forward. Answer: Call for ruptured cartridge extractor.

*d. Fourth position stoppage.*—(1) Cock rifle. Insert empty cartridge case in chamber. Replace loaded magazine. Have man pull trigger. Answer: Call for cleaning rod—examine extractor.

(2) Set change lever on "safe."

### SECTION III

#### MARKSMANSHIP, KNOWN DISTANCE TARGETS

■ 200. TRAINING.—*a. General.*—(1) Training is preferably organized and conducted as outlined in paragraphs 52 and 53. Officers should generally be considered as the instructors of their units. As only one step is taken up at a time, and as each step begins with a lecture and a demonstration showing exactly what to do, the trainees, although not previously instructed, can carry on the work under the supervision of the instructor.

(2) It is advisable that personnel to fire be relieved from routine garrison duty during the period of preparatory marksmanship training and range practice with the automatic rifle.

*b. Place of assembly for lectures.*—Any small ravine or cup-shaped area makes a good amphitheater for giving the lecture in case no suitable building is available.

■ 201. ASSISTANT INSTRUCTORS.—*a.* It is advantageous to have all officers and as many noncommissioned officers as possible trained in advance in the prescribed methods of instruction. When units are undergoing automatic rifle marksmanship training for the first time this is not always practicable. A good instructor can give a clear idea of how to carry on the

work in his lecture and demonstration preceding each step. In the supervision of the work following the demonstration he can correct any mistaken ideas or misinterpretations.

b. When an officer in charge of automatic rifle instruction is conducting successive organizations through target practice, it is advisable to attach officers and noncommissioned officers of the units to follow to the first organization taking the course for the period of preparatory work and range finding. These act as assistant instructors when their own companies take up the work. Such assistants are particularly useful when one group is firing on the range and another is going through the preparatory exercises, both under the supervision of one instructor.

■ 202. EQUIPMENT.—a. All equipment used in the preparatory exercises must be accurate and carefully made. One of the objects of these exercises is to cultivate a sense of exactness in the minds of the men undergoing instruction. They cannot be exact with poor equipment.

b. The instructor should personally inspect the equipment for the preparatory exercises before the training begins. A set of model equipment should be prepared in advance by the instructor for the information and guidance of the organization about to take up the preparatory work. The sighting bars must be made as described, and the hole representing the peep sight must be absolutely circular. If the sights are made of tin, the holes should be bored by a drill. Good rear sights can be made for the sighting bars by using cardboard and cutting the holes with a punch of the type used for cutting wads for 10-gage shotgun shells. Silhouettes painted on a white background are not satisfactory. The silhouette targets from the M1 1,000-inch target pasted on tin or stiff backing make the best aiming points either for sighting and aiming exercises or for use in position and trigger manipulation exercises.

■ 203. INSPECTION OF RIFLES.—No man is required to fire with an unserviceable or inaccurate rifle. All automatic rifles should be carefully inspected far enough in advance of the period of training to permit organization commanders to replace all inaccurate or defective rifles. Automatic rifles

having badly pitted barrels are not accurate and should not be used.

■ 204. AMMUNITION.—The best ammunition available should be reserved for record firing, and the men should have a chance to learn their sight settings with that ammunition before record practice begins. Ammunition of different makes and of different lots should not be used indiscriminately.

■ 205. ORGANIZATION OF THE WORK.—*a. In preparatory training.*—(1) The field upon which the preparatory work is to be given should be selected in advance and a section of it assigned to each group. The equipment and apparatus for the work should be on the ground and in place before the morning lecture is given, so that each group can move to its place and begin work immediately and without confusion. Figure 44 shows a suggested organization for the work when a number of groups are undergoing instruction at the same time.

(2) Each company should be organized in two lines, facing away from each other. In this way the instructors, whose position is normally between the lines, have all of their men under close supervision.

(3) The arrangement of the equipment is as follows:

(a) On each line are placed the sighting bars and rifle rests at sufficient intervals to permit efficient work.

(b) Fifty feet from each line is placed a line of small boxes with blank paper tacked on one side, one box and one small sighting disk to each rifle rest.

(c) Two hundred yards from each line is placed a line of frames suitable for use in making triangles at 200 yards, one frame to each squad. These frames have blank paper tacked or pasted on the front. A long range sighting disk is placed with each frame. Machine-gun targets make acceptable frames for this work.

(4) In position and trigger manipulation exercises, targets should be placed at 1,000 inches and 200 yards.

(5) When sufficient level ground is not available for the above arrangement, the organizations will have to vary from it in some particulars. It will nearly always be found, however, that all of the work except making triangles at 200 yards can be carried on in two lines.

*b. In range practice.*—(1) The range work should be so organized that there is a minimum of lost time on the part of each man. Long periods of inactivity while awaiting a turn in the firing line should be avoided. For this reason the number of men on the range should be accommodated to the number of targets available.

(2) As a general rule six men per target is about the maximum and four men per target the minimum for efficient handling.

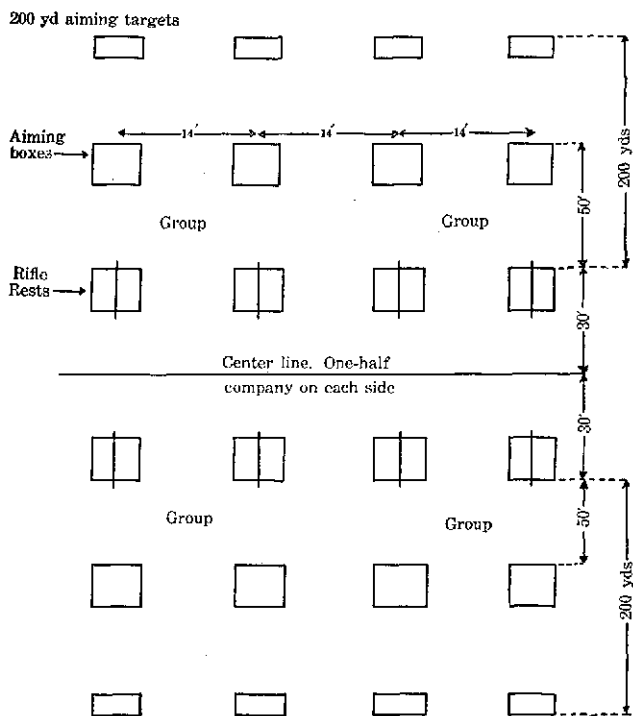

FIGURE 44.—Portion of field laid out for sighting and aiming exercises.

■ 206. MODEL SCHEDULES.—The following schedules are suggested for guides in a course in preparatory marksmanship and firing course A:

*a. Preparatory training.*

Subject	Time allotted	Day
	<i>Hours</i>	
Purpose of preparatory marksmanship training.....	¼	1st
First step: Sighting and aiming exercises—		
Explanation and demonstration.....	¼	
First sighting and aiming exercise.....	¼	
Sight blackening and second sighting and aiming exercise.....	¾	
Third sighting and aiming exercise.....	2	
Second step: Position exercises—		
Explanation and demonstration.....	½	
Gun sling adjustment; trigger slack; holding the breath; general rules for positions.....	¼	
Prone position, bipod rest.....	1	
Sitting position.....	½	
Kneeling position.....	1	
Assault fire.....	½	
Review of positions.....	1	2d
Sight setting and aiming exercises.....	1	
Third step: Trigger manipulation exercises—		
Explanation and demonstration.....	½	
Trigger manipulation exercise, prone position with bipod rest.....	1	
Trigger manipulation exercise, sitting.....	½	
Trigger manipulation exercise, kneeling.....	1	
Effect of wind; sight changes; use of score book <sup>1</sup> .....	1	
Examination of all men by section and platoon leaders in all preparatory subjects and exercises <sup>2</sup> .....	2	

<sup>1</sup> The use of the score book and effects of light and wind will be taken up with men who are not actually on the line undergoing instruction.

<sup>2</sup> Lack of proficiency disclosed by examination will be corrected at once by additional instruction.



*b. Range practice, course A.*

Subject	Time allotted	Day
	<i>Hours</i>	
Automatic fire exercises, 1,000-inch range.....	½	3d.
Exercises in replacing magazines.....	½	
Fire tables I and II (each score preceded by a simulated run for each man).	7	
Fire tables III and IV (each score preceded by a simulated run)	8	4th.
Fire table V (each score preceded by a simulated run).....	4	5th.
Fire table VI (each score preceded by a simulated run).....	4	
Record practice (course A)— Fire table VII.....	8	6th.

NOTE.—The time allotted for firing the known distance range is based on six orders per target and a simulated run preceding each practice for each man.

*c. For courses B, C, and D.*—The preparatory exercises and 1,000-inch firing are the same as in course A. All other firing is conducted in a manner similar to course A, reducing the time accordingly.

■ 207. LECTURES AND DEMONSTRATIONS.—*a.* Lectures may be given at the beginning of each step of the instruction to the assembled automatic riflemen of the unit undergoing training to facilitate the work.

*b.* The notes on lectures which follow are to be used merely as a guide. The points which experience has shown to be the ones which usually require elucidation and demonstration are placed in headings in italics. The notes which follow each heading are merely to assist the instructor in preparing his lecture.

*c.* It is important to show the men undergoing instruction, by explanation and demonstration, just how to go through the exercises and to tell them why they are given these exercises.

■ 208. FIRST LECTURE: SIGHTING AND AIMING.—*a.* The group is assembled in a suitable outdoor location or in a building.

b. The following equipment is necessary for the demonstration:

- 1 sighting bar.
- 1 automatic rifle rest.
- 1 automatic rifle.
- 1 small sighting disk.
- 1 long range sighting disk.
- 1 small box.
- Material for blackening sights.

c. The following subjects are the ones usually discussed in the first lecture:

(1) *Value of automatic rifle fire.*—(a) The automatic rifle greatly increases the fire effect of the rifle platoon.

(b) Individual proficiency consists in the automatic rifleman's ability to place a large volume of accurate fire upon appropriate targets.

(2) *Object of target practice.*—(a) To attain this individual proficiency.

(b) To show riflemen how to teach others.

(c) To train future instructors.

(3) *Method of instruction.*—(a) The instruction is divided into steps. The man is taught each step and practices it before going to the next step. When he has been taught all of the steps he is taken to the known distance range to apply what he has learned.

(b) Careful instruction in the various preparatory steps will be of material benefit in range practice.

(c) Explain coach and pupil method. Why used.

(4) *Reflecting attitude of instructor.*—If the instructor is interested, enthusiastic, and energetic, the men will follow his example.

(5) *Examination of men on preparatory work.*—Each man is examined in the preparatory work before going to the range. An outline of this examination is given in paragraph 72.

(6) *Method of marking blank form.*—Explain blank form, paragraph 72. Explain marking system by the use of a blackboard, if available.

(7) *Five essentials to automatic rifle marksmanship.*

Correct sighting and aiming.

Correct position.

Correct trigger manipulation.

Correct application of automatic fire fundamentals.

Knowledge of proper sight adjustments.

(8) *Today's work.*—First step, sighting and aiming.

(9) *Demonstration of first sighting and aiming exercise.*—Require a previously trained group to demonstrate just how this exercise is carried on.

(10) *Blackening the sights.*—Explain why this is done and demonstrate it.

(11) *Demonstration of second sighting and aiming exercise.*—Require a previously trained group to demonstrate the second sighting and aiming exercise.

(12) *Demonstration of third sighting and aiming exercise.*

(a) Require a previously trained group to demonstrate the third sighting and aiming exercise.

(b) Show how the group is organized by the coach and pupil method so as to keep each man busy all the time.

(13) *Long range shot group work.*—Show the class the disk for 200-yard shot group work. Explain how this work is carried on and why. Show some simple system of signals that may be used.

(14) *Final word.*—(a) Start keeping your blank form today.

(b) Organize your work so that all men are busy at all times.

(15) Are there any questions?

(16) Next lecture will be ----- (State hour and place.)

■ 209. SECOND LECTURE: POSITION.—a. The following equipment is necessary for the demonstrations in this lecture:

1 automatic rifle with sling.

1 box with small aiming target.

b. The following subjects are the ones usually discussed in the second lecture:

(1) *Importance of each step.*—(a) Each step includes all that has preceded.

(b) Each step must be thoroughly learned and practiced or the instruction will not be a success.

(2) *Necessity for correct positions.*—Correct and comfortable positions are essentials of automatic rifle marksmanship.

The prone position is especially important. Instruction in positions involves correct aiming.

(3) *Gun sling*.—State that the sling is used in the kneeling and sitting positions but not in the prone or in the antiaircraft firing position. Demonstrate the adjustments of the loop and hasty sling and explain why they are used.

(4) *Taking up the slack*.—Show the class the slack on the trigger. Explain why it is taken up in the position exercises. (Cannot begin to press the trigger until the slack has been taken up.)

(5) *Holding the breath*.—Explain the correct manner of holding the breath and have the class practice it a few times. Explain how the coach observes the pupil's breathing by watching his back.

(6) *Position of the thumb*.—May be either over the stock or on top of the stock but never along the side of the stock. Explain why.

(7) *Joints of the finger*.—Trigger may be pressed with first or second joint. Second joint preferable when it can be done conveniently.

(8) *Prone position*.—(a) Demonstrate correct prone position with bipod rest calling attention to the elements which go to make up a correct prone position; body straight behind piece, legs spread well apart, position of the butt on the shoulder, position of the hands on the rifle, position of cheek against the stock, position of elbows. Demonstrate adjusting the bipod.

(b) Mention the usual faults which occur in prone position and especially the fault of having the body at an angle to the piece.

(c) Demonstrate the correct position again.

(9) *Sitting position*.—Demonstrate in the same manner as described above for the prone position.

(10) *Kneeling position*.—Demonstrate in the same manner as described above for the prone position.

(11) *Today's work; position exercises*.—(a) Demonstrate the duties of a coach in a position exercise calling attention to each item.

(b) Demonstrate the position of the coach. Always placed so that he can watch the pupil's finger and eye.

(c) Show how the instructor organizes a group by employing the coach and pupil method so as to keep every man occupied.

(d) Continue the long range shop group work today.

(12) *Do not press the trigger today.*—Take up the slack in these exercises but do not press the trigger.

(13) *Keep blank forms up to date.*—Examine each man in the group at the end of the day's work and assign him a mark.

(14) Are there any questions?

(15) Next lecture will be ----- (State hour and place.)

■ 210. THIRD LECTURE: TRIGGER MANIPULATION.—*a.* The following equipment is necessary for the demonstration:

1 automatic rifle.

1 box with small aiming target.

*b.* The following subjects are the ones usually discussed in the third lecture:

(1) *Trigger manipulation important.*—Explain that trigger manipulation for the automatic rifle differs materially from the procedure employed in firing the Springfield or M1 rifle or the caliber .30 heavy machine gun. Marksmanship with the Browning automatic rifle, caliber .30, M1918A2, embraces two classes of fire, both of which are obtained by appropriate trigger manipulation with the automatic rifle set to fire at its slow cyclic rate. These two classes of fire and the trigger manipulation for each will be separately discussed.

(a) *Firing single shots.*—Single shots are fired by taking up the slack and pressing the trigger, being careful to maintain the alinement of the sights while the bolt is going home. An immediate release of the trigger is required when the bolt is released. Most men are able to attain this quick trigger release with a little practice. Explain to the group that if sometimes two or three shots instead of a single shot are obtained it makes no serious difference. Inform the group that in such event in qualification practice the several shots which are thus fired are included in the score. Explain that this is necessary because the weapon is not equipped with an adjustment for semiautomatic fire. Explain that single shots fired as explained above give a very effective form of field

firing when it is necessary to conserve ammunition or for other tactical reasons.

(b) *Firing short bursts.*—Short bursts are fired by taking up the slack and pressing the trigger, retaining the pressure for the length of burst desired. Short bursts of three to five rounds are utilized in the marksmanship courses. Most men are able to manipulate the trigger to obtain such bursts with a little practice. Explain that these short bursts constitute the type of fire employed in the field when it is desired to take full tactical advantage of the fire power of this weapon. Explain that longer bursts would be seldom profitable in field firing and are not justified by the ammunition supply available to this weapon in the platoon.

(2) *Pulsations of body.*—In firing single shots in the sitting and kneeling positions, the natural movements of the body and its pulsations produce more or less parallel movement of the automatic rifle. These are not sufficient to affect the shot, and the alinement of the sights is maintained as steadily as possible without worrying about these small and natural displacements of the aim as the trigger is pressed and the bolt is going home.

(3) *Aim and hold.*—Any man can easily learn to hold a good aim for 5 to 10 seconds, which is a much longer period than is necessary to fire a well-aimed single shot.

(4) *Calling the shot.*—Explain calling the shot and why it is done. (See par. 65d.)

(5) *Today's work; trigger manipulation exercise.*—(a) Demonstrate the duties of a coach in the trigger manipulation exercises by calling attention to each item.

(b) The work is carried on as in position exercises with the pressing of the trigger added.

(c) Practice trigger manipulation for firing bursts and for firing single shots in the prone position only this morning.

(d) Finish up the making of long range shot groups today.

(6) *Keep blank form up to date.*—Examine each man in the group at the end of the day's work and assign him a mark.

(7) Are there any questions?

(8) Next lecture will be ----- (State hour and place.)

■ 211. FOURTH LECTURE: AUTOMATIC FIRE AND REPLACING MAGAZINES.—*a.* The following equipment is necessary for the demonstration:

1 automatic rifle.

2 magazines.

1 U. S. rifle, caliber .30, M1 target.

*b.* The following subjects are the ones usually discussed in the fourth lecture:

(1) *Meaning of automatic fire.*—Repeat the fact that automatic fire employs short bursts and the slow cyclic rate. Rapidity in sustained fire comes from skill in changing magazines.

(2) *Keeping the eye on the target.*—Explain the advantages of this and how it gains time.

(3) *Application in war.*—Explain the advantages of keeping the eye on the target in combat.

(4) *Automatic fire exercises.*—(a) Explain how the exercise is carried on.

(b) Demonstrate and call attention to each item.

(5) *Replacing magazine drill.*—(a) Explain how the exercise is carried on.

(b) Demonstrate and call attention to each item.

(6) *Today's work; automatic fire exercise and replacing magazine drill.*—The remaining time today will be given to automatic fire exercises and drill in replacing magazines. The exercises will be repeated in short periods until each man is proficient.

(7) *Keep blank forms up to date.*—Examine each man in the squad at the end of the day's work and assign him a mark.

(8) Are there any questions?

(9) Next lecture will be ----- (State hour and place.)

■ 212. FIFTH LECTURE: EFFECT OF WIND AND LIGHT; SIGHT CHANGES; SCORE BOOK.—*a.* This part of the preparatory instruction can be given on any day on which the weather forces the work to be done indoors. If no bad weather occurs, this work should follow the fourth lecture.

b. The following equipment is necessary for the demonstrations:

1 D target (to be mounted on a frame and marked with the proper windage lines).

5 spotters that can readily be stuck into the target.

Rifle and score book for each man.

c. The following subjects are the ones usually discussed in the fifth lecture:

(1) *Targets.*—(a) Explain the divisions on the target and give the dimensions of each.

(b) Call attention to windage lines. Have class compare them with diagram in the score book. Explain why lines are farther apart as the range increases.

(2) *Weather conditions.*—All weather conditions disregarded except wind.

(3) *Wind.*—(a) Explain how the direction of the wind is described.

(b) Explain how the velocity of the wind is estimated.

(c) Explain the effect of wind. This effect increases with the distance from the target.

(4) *Windage for first shot.*—Show windage diagram in the individual score book and explain its use as set forth in paragraph 68.

(5) *Wind gage rule.*—State rule and explain it (par. 68).

(6) *Elevation rule.*—State rule and explain it (par. 69).

(7) *Light.*—Explain effect.

(8) *Score book.*—(a) Explain use of score book on range.

(b) Have class open score books and explain items of keeping score.

(9) *Exercises.*—Give the class a number of small problems as a demonstration as to how the day's work is to be carried on.

(10) *Today's work.*—(a) Study and practice in sight setting, sight changing, and use of score book. Instructors will work up problems for their groups.

(b) Additional practice in the exercises of the preceding days.

(11) Are there any questions?

(12) Next lecture will be ----- (State hour and place.)



■ 213. **SIXTH LECTURE: RANGE PRACTICE.**—This lecture and demonstration should immediately precede range firing. If the class is not too large it should be given on a firing point of the rifle range.

*a.* The following equipment is necessary for the demonstrations:

Material for blackening sight.

1 automatic rifle with gun sling.

Corrugated type dummy cartridges (par. 17).

*b.* The following subjects are the ones usually discussed in the sixth lecture.

(1) *Preparatory work applied.*—Range practice is carried on practically the same as the preparatory exercises except that ball cartridges are used.

(2) *Coaching.*—Coach watches the man not the target. Coach does not keep the score for the pupil. Pupil must make his own entries in his score book. Coach sees that he does this.

(3) *Officers and noncommissioned officers.*—(a) Supervise and prompt the men acting as coaches.

(b) Personally coach pupils who are having difficulty in making good scores.

(4) *Spotters.*—Use in firing with and without time limit.

(5) Read safety precautions.

#### SECTION IV

#### MARKSMANSHIP, AIR TARGETS

■ 214. **PRELIMINARY PREPARATION.**—*a.* The officer in charge of automatic rifle antiaircraft training should be thoroughly familiar with the subject; should have detailed at least three officers as assistant instructors; and should train the assistant instructors and a demonstration group consisting of at least 16 men before the first training period.

*b.* He should inspect the range and equipment in sufficient time prior to the first training period to permit correction of deficiencies.

■ 215. **DESCRIPTION OF MINIATURE RANGE.**—*a.* *Horizontal target.*—This target is designed to represent a sleeve target towed by an airplane flying parallel to the firing point.

*b. Double diving and climbing target.*—This target is in two sections. The right section is designed to represent a sleeve target towed so as to pass obliquely across the front of the firing line in the manner of an airplane diving, if run from left to right, or climbing, if run from right to left. The left section is the same but represents an airplane diving from right to left and climbing from left to right.

*c. Overhead target.*—This target is designed to represent a sleeve target towed by an airplane which is approaching the firing line and will pass overhead, or when run in the opposite direction represents an airplane that has passed over the firing line from the rear.

*d. Size and speed of silhouette.*—The black silhouette is a representation at 500 inches of a 15-foot sleeve at a range of 330 yards. It is 7.5 inches long. The speed of the silhouette should be between 15 and 20 feet per second. This speed represents that of an airplane flying between 150 and 200 miles per hour at a range of 200 yards. The size and speed of the silhouette are based upon the time of flight of the caliber .22 bullet for 500 inches. This time of flight is approximately 0.04 second. When the target is moving at a speed of 15 feet or 180 inches per second it will move  $180 \times .04$  or 7.2 inches. Therefore, in order to hit the silhouette the aim must be directed approximately one silhouette length in front of it. If two or three target length (silhouette lengths) leads are used, the shot will hit in the appropriate scoring spaces. This does not hold equally true on the overhead target. If the shot is fired when the range is less than 500 inches from the firer, the lead necessary will be less than one target length.

■ 216. PREPARATORY EXERCISES.—*a.* A method of conducting the preparatory exercises is given in paragraph 133.

*b.* Each assistant instructor is assigned a target and conducts the preparatory training and firing of all groups on his target.

*c.* In preparatory training coach and pupils should change places frequently.

*d.* Forty-five minutes at each type of target should be sufficient to train each soldier in the preparatory exercises.

e. A detail of 1 noncommissioned officer and 4 or 6 men should be provided to operate each type of target.

■ 217. MINIATURE RANGE FIRING.—a. (1) *Caliber .22 rifle.*—

(a) The rifle should have the open sight.

(b) Two magazines for each caliber .22 rifle should be provided.

(c) Ammunition should be available immediately in rear of the firing line at each type of target.

(d) Coaches should load magazines as they become empty.

(e) Scorers should be detailed for each type of target. After each score is fired, they score the target. They call off the number of hits made on each silhouette and pencil the shot holes. The coaches enter the scores on the firer's score card.

(f) A platform permitting the scorer to score the target should be provided for each type of target.

(g) To stimulate interest, the instruction can be concluded with a competition between individuals, squads, or training groups.

(h) Targets as shown on figure 45 may be used on non-overhead targets for group firing or competition. Only one target length lead may be used in firing on this target.

(i) Considerable supervision is required in order to maintain target operation at the proper speed. This speed is necessary because the lead is based upon a speed of from 15 to 20 feet per second.

(j) Safety precautions must be constantly observed.

(k) Preparatory exercises using the caliber .22 rifle precede firing that weapon.

(2) *Browning automatic rifle, caliber .30, M1918A2.*—If the size of the danger area permits, this rifle is fired on the miniature range. Such firing is conducted in the same manner as with the caliber .22 rifle, with the following exceptions:

(a) The battle sight only is used.

(b) The lead necessary to hit the black silhouette is approximately 2.5 inches. This is due to the difference in the time of flight of the caliber .30 and caliber .22 bullets for 500 inches. The time of flight of the caliber .30 bullet for 500 inches is 0.015 second. When the target is operated at the speed of 15 or 20 feet per second, the silhouette will move

approximately 2.5 inches during the time of flight of the bullet.

b. Using the battle sight the line of aim is lower than the trajectory of the bullet. Therefore it will be necessary to aim low in order to hit the silhouette.

c. Men must be constantly cautioned to keep the weight of the body forward. This is to prevent them from being pushed over by the recoil of the weapon.



FIGURE 45.

d. Preparatory exercises using the Browning automatic rifle, caliber .30, M1918A2, precede firing that weapon.

■ 218. TOWED TARGET FIRING.—*a. Range organization.*—(1) Individual firing at a towed target being impracticable, all members of a rifle platoon, including both rifles and automatic rifles, are usually constituted as a group for such firing. A

group the size of a platoon is the most convenient group for such firing.

(2) An ammunition line should be established 10 yards in rear of the firing line. Small tables at the rate of 1 per 10 men in a firing group are desirable.

(3) Immediately in rear of the ammunition line the ready line should be established.

(4) The first platoon or similar group to fire is deployed along the ready line with each individual in rear of his place on the firing line. Other platoons or similar groups are similarly deployed in a series of lines in rear of the first unit to fire.

(5) Upon command of the officer in charge, the group on the ready line moves forward to the firing line securing ammunition en route; other groups close up.

(6) Upon completion of firing by one group it moves off the firing line passing around the flanks of the ready line so as not to interfere with the group moving forward.

(7) An ammunition detail sufficient to issue ammunition to groups as they move forward to the firing line and to collect unfired ammunition from the group which just completed firing should be provided. These two operations should be performed simultaneously. Unfired ammunition is delivered to the statistical officer.

(8) The officer in charge should have at least three assistants, two safety officers and one statistical officer.

*b. Ammunition.*—(1) Ball or tracer ammunition may be used. Tracer ammunition is useful to show the groups waiting to fire the size and density of the cone of fire delivered by the firing group.

(2) Tracer ammunition will assist the officer in charge in verifying the lead announced in the fire order. It also provides a means of checking the firer's estimate of the lead ordered.

*c. Technique of antiaircraft fire.*—(1) *Leads.*—The lead used in the technique of antiaircraft fire described in paragraph 130*b* is the average of two theoretical extremes. For example: If the maximum slant range to a passing airplane is 600 yards and the minimum slant range is 300 yards, the lead used would be that required for a slant range of 450

yards. Fire is delivered with one fixed lead in order to simplify the procedure. Experience indicates such a technique is readily taught and that it is effective. The lead table given below may be helpful. It is based upon a 15-foot sleeve towed at 200 miles per hour and caliber .30 M2 ammunition.

Slant range:	<i>Lead required</i>
100-----	2
200-----	5
300-----	8
400-----	11
500-----	14
600-----	18

(2) *Fire distribution.*—The usual technique of fire is described in paragraph 130. If time and ammunition allowances permit, other methods may also be taught.

(3) *Variable lead method.*—(a) In this method the automatic rifleman fires each round with a different lead. The maximum lead is used when the target enters and again when it leaves the firing area. The minimum lead is used when the target is directly opposite the firing line. Example: If three rounds are to be fired as the sleeve target passes across the front of the firing line, the first round is fired shortly after the target enters the firing area; the second round is fired when the target is near the center of the firing area; the third round is fired shortly before the sleeve leaves the firing area. The fire order given by the officer in charge is: 1. SLEEVE TARGET APPROACHING FROM THE LEFT (RIGHT), 2. LOAD, 3. 14-18-14 TARGET LENGTH LEADS, 4. THREE ROUNDS, 5. COMMENCE FIRING. In this example it is expected that the three rounds will be fired at slant ranges of approximately 500 yards, 300 yards, and 500 yards.

(b) This method has given good results but is more difficult to apply than the prescribed method.

(4) *Safety precautions.*—Safety precautions as given in paragraph 143 must be rigidly enforced. This requires constant supervision by the officer in charge.

*d. Record.*—The results of all towed target firing should be recorded and analyzed. The statistical officer should record the total number of rounds fired and the hits obtained on each target. If the number of hits falls below the number expected, the reason should be sought and explained to the men. On the other hand, when results are satisfactory the men should be impressed with the value of rifle antiaircraft fire.

*e. Estimating ranges.*—(1) Training in estimating ranges of air targets is conducted by having individuals observe airplanes flying at known ranges. The individual bases his estimate on the appearance of the airplane at key ranges. The following estimates, based on an O-46 observation plane, 1936, will be useful:

At 1,000 yards' range you can see the general outline of the plane; at 700 yards, the wheels, rudder, wing struts, and tail skid; at 500 yards, the antenna and small projections from the fuselage; at 200 yards, symbols and numbers—letters can be seen plainly.

(2) A flying mission of from 1 to 2 hours is sufficient for the instruction of a large group in estimating ranges.

## SECTION V

### TECHNIQUE OF FIRE

■ 219. GENERAL.—The instructor should secure necessary equipment, inspect ranges, detail and train necessary assistants, including demonstration units, prior to the first period of instruction. Instructors should use their initiative in arranging additional exercises in the application of the fundamentals and methods herein contained. It should be explained to trainees how the exercises used illustrate the methods in the technique of fire. Good work in the conduct of the exercises as well as errors should be called to the attention of all trainees.

■ 220. RANGE ESTIMATION.—*a.* A number of ranges to prominent points on the terrain should be measured so that a few minutes of each period can be devoted to range estimation.

*b.* Range cards as shown below will be of assistance in figuring percentage of errors.

## RANGE ESTIMATION

Name .....

Company .....

Squad .....

No.	Estimate	Correct	%	Remarks	No.	Estimate	Correct	%	Remarks
1					21				
2					22				
3					23				
4					24				
5					25				
6					26				
7					27				
8					28				
9					29				
10					30				
11					31				
12					32				
13					33				
14					34				
15					35				
16					36				
17					37				
18					38				
19					39				
20					40				

(Front)



TABLE FOR COMPUTING ERRORS IN RANGE ESTIMATION

Range in yards	Error in yards										
	5	10	15	20	25	30	35	40	45	50	100
250	2	4	5	8	10	12	14	16	18	20	40
275	2	4	5	8	9	11	13	15	16	18	36
300	2	3	5	7	8	10	12	13	15	17	33
330	2	3	5	6	8	9	11	12	14	15	30
350	1	3	4	6	7	9	10	11	13	14	29
380	1	3	4	5	7	8	9	11	12	13	26
400	1	3	4	5	6	8	9	10	11	13	25
420	1	2	4	5	6	7	8	10	11	12	24
440	1	2	3	4	6	7	8	9	10	11	23
460	1	2	3	4	5	7	8	9	10	11	22
480	1	2	3	4	5	6	7	8	9	10	21
500	1	2	3	4	5	6	7	8	9	10	20
520	1	2	3	4	5	6	7	8	9	10	19
540	1	2	3	4	5	6	7	8	9	10	19
560	1	2	3	4	4	5	6	7	8	9	18
580	1	2	3	3	4	5	6	7	8	9	17
600	1	2	3	3	4	5	6	7	8	8	17
620	1	2	2	3	4	5	5	6	7	8	16
640	1	2	2	3	4	5	5	6	7	8	16
660	1	2	2	3	4	5	5	6	7	8	15
680	1	1	2	3	4	4	5	6	7	8	15
700	1	1	2	3	3	4	5	6	6	7	14
720	1	1	2	3	3	4	5	6	6	7	14
740	1	1	2	3	3	4	5	6	6	7	14
760	0	1	2	3	3	4	5	5	6	7	13
780	0	1	2	3	3	4	4	5	6	6	13
800	0	1	2	3	3	4	4	5	6	6	13
850	0	1	2	2	3	3	4	5	5	6	12
900	0	1	2	2	3	3	4	4	5	6	11
950	0	1	2	2	3	3	4	4	5	5	11
1,000	0	1	2	2	3	3	4	4	5	5	10

NOTE.—Example of the use of this table: Suppose the correct range to be 695 yards and the estimated range to be 635. The "error in estimate" is consequently 60 yards. Select two "errors in estimate" in the 700-yard space (the nearest to the correct range given in the table) whose sum is 60 yards, as 50 and 10. Add the percentages shown thereunder, and the result will be approximately your error. In this case:

$$7 \text{ plus } 1 = 8\%$$

(Rear)

■ 221. TARGET DESIGNATION.—The time devoted to target designation should include careful instruction in target designation by each of the three usual methods: use of tracer bul-

lets; pointing; oral description. While more time is required to teach the third method, it must be impressed on the men that all of the methods are important and have their application. Instruction is preferably conducted on varied terrain.

■ 222. AUTOMATIC RIFLE FIRE AND ITS EFFECT.—This step in instruction can best be covered by the use of a blackboard and several automatic riflemen firing tracer bullets to demonstrate the trajectory, danger space, dispersion, and classes of fire.

■ 223. APPLICATION OF FIRE.—*a.* Sufficient time and explanation should be devoted to the method of fire distribution to insure that all men fully understand it and can explain it in their own words.

*b.* A demonstration group simulating firing should suffice to show the technique employed in assault fire.

■ 224. LANDSCAPE TARGET FIRING.—*a.* An explanation and demonstration will be necessary to show the technique and procedure of zeroing rifles and the firing of exercises on the landscape targets.

*b.* Units should be given practical work in writing fire orders for targets on the landscape panels prior to their firing of any exercises.

■ 225. ASSAULT FIRE.—*a.* After the completion of record practice and subject to authorized ammunition allowances, all men who have completed record practice, with the exception of antiaircraft troops, may fire the following table:

ASSAULT FIRE

Range (yards)	Time (seconds)	Shots	Target	Position	Remarks
100	No limit	10	Assault fire (par. 225 <i>b</i> ).	Assault fire	
100-25	60	20	do	do	Two magazines of 10 rounds each. (Fire while steadily advancing)

b. The target is a screen 10 feet long and 3 feet high, with three prone silhouette targets placed 1 yard apart directly in front of the screen. After the firing each soldier marches up to the target to examine the effects of his firing.

■ 226. FIELD TARGET FIRING.—*a.* The most difficult factor in the preparation of problems for field firing is the selection of the terrain which complies with the safety regulations contained in AR 750-10. A drawing should be made on a map showing all safety angles, target positions, and other required data.

*b.* The appearance of the ordinary prone or kneeling silhouette (E or F target) depends a great deal upon the direction of the sun, the background of the targets, and the angle at which the targets are placed. The effect of solidity can be obtained by using two figures placed at right angles to one another. The effect of fire distribution on a linear target can be determined by using a screen of E targets nailed end to end. The screen should be located so as not to disclose the position of concealed targets.

*c.* Maximum use should be made of the available terrain to permit the firing of as many squads from one firing position at one time as is possible. This firing should be controlled from a central location. Telephone communication between the firing point and the pits will facilitate this instruction. During this type of training, individuals and units should approach and occupy their firing positions with due regard to cover and concealment, after which men are rearranged on the firing position according to the requirements of safety.

*d.* When sufficient time and ammunition are available, platoon exercises should be conducted.

*e.* About 60 to 70 percent of the score allotted for the grading of units should be given for such parts of the exercise as the approach march and occupation of the firing position, fire orders, time required to open fire, rate of fire, and fire control. The remaining 30 or 40 percent should be given for the number of hits on the targets and the number of targets hit.

*f.* A 13-week training schedule should include about 31 hours for this instruction.



## INDEX

	Paragraph	Page
Accessories.....	38	46
Advice to instructors, purpose.....	197	175
Aiming and leading exercises (second step).....	135	123
Air targets.....	126	118
Align front sight.....	81	91
Aligning silhouettes and sights (second sighting and aiming exercise).....	56	58
Ammunition.....	39, 102, 204, 49, 103,	178
Ballistic data.....	46	52
Care, handling, and preservation.....	44	51
Classification.....	40	49
Grade.....	42	49
Identification.....	43	50
Lot number.....	41	49
Storage.....	45	51
Antiaircraft fire, technique.....	127	118
Individual.....	130	119
Application of fire.....	175, 223	160, 198
Assault fire.....	177, 225	161, 198
Position.....	62	66
Assembling magazine.....	10	11
Assembling rifle.....	9	9
Assistant instructors.....	201	176
Automatic fire and replacing magazines (fourth lecture).....	211	187
Automatic fire exercise.....	66	70
Automatic rifle fire, effect.....	222	198
Ballistic data.....	46	52
Beaten zone.....	171	157
Buffer and rate-reducing mechanism, functioning.....	21	29
Bullets, tracer.....	163	150
Care and cleaning of rifle.....	13	19
Care in disassembling and assembling.....	6	3
Care of ammunition.....	44	51
Change lever, to set.....	23, 30	33, 38
Classes of fire.....	172	159
Classification of ammunition.....	40	49
Coaches, duties.....	54	56
Coaching.....	80	90
Prohibited.....	98	102
Concentrated fire.....	176	160
Conduct of training.....	198	175
Courses, marksmanship.....	75	82
Courses to be fired.....	142	131
Critique.....	195	172
Cycle of functioning.....	19	23
Description.....	20	24
Danger space.....	168	157
Definitions.....	152	145

INDEX

	Paragraph	Page
Delivery of fire.....	131	119
Demonstration of trajectories.....	174	159
Demonstrations.....	207	181
Description:		
Functioning cycle.....	20	24
Miniature range.....	215	189
Rifle.....	2	1
Target.....	184	164
Determine zero of rifle.....	82	91
Disassembling—		
Magazine.....	12	13
Rifle.....	8	4
Dispersion.....	169	157
Distributed fire.....	176	160
Dummy cartridges, use.....	17, 25, 78	22, 36, 90
Duties:		
Coaches.....	54	58
Leaders.....	52, 182	55, 163
Effect:		
Automatic rifle fire.....	222	198
Fire.....	173	159
Wind and light (fifth lecture).....	212	187
Elevation.....	69	74
Equipment.....	51, 202	54, 177
Estimation by eye.....	159	147
Examination.....	72	74
Exercises.....	166, 190	154, 169
Aiming and leading (second step).....	135	123
Automatic fire.....	66	70
Position.....	58	60
First step.....	134	123
Preparatory.....	133, 216	121, 190
Replacing magazines.....	67	71
Sequence.....	88	96
Sight setting.....	63	68
Sight setting and aiming.....	64	68
Sighting and aiming.....	55-57, 64	57-59, 68
Situations for firing.....	194	172
Suggested.....	196	173
Trigger manipulation.....	65	69
Third step.....	136	124
Explanation of zero.....	70	74
Extractor, to remove and replace without disassembling.....	11	12
Field target firing.....	191, 226	170, 199
Scope of training.....	192	170
Fifth lecture (effect of wind and light; sight changes; score book).....	212	187
Fire:		
Application.....	175, 223	160, 198
Assault.....	177, 225	161, 198
Classes.....	172	159
Concentrated and distributed.....	176	160
Control.....	180	161
Delivery.....	131	119

## INDEX

Fire—Continued.	Paragraph	Page
Discipline.....	179	161
Effect.....	173	159
Automatic rifle.....	222	198
Importance of rifle.....	153	145
Observation.....	158	146
Orders.....	87, 181	96, 162
Rate.....	178	161
Technique.....	219	195
Fire power of rifle.....	3	1
Fire rifle.....	29	37
Firer, shelter for.....	100	102
Firing:		
Exercises, situation for.....	194	172
Field target.....	191, 226	170, 199
Group.....	140	130
Instruction.....	139	129
Landscape target.....	224	196
Miniature range.....	217	191
On wrong target.....	111	104
Procedure.....	144, 188	133, 168
With time limit.....	96	100
Without time limit.....	95	99
Sequence.....	74	82
Towed target.....	141, 218	131, 192
Firing line, organization.....	92	98
Firing pin, to remove without disassembling.....	10	11
Firing points.....	79	90
First lecture (sighting and aiming).....	208	181
First sighting and aiming exercise (sighting bar).....	55	57
First step (position exercises).....	134	123
Fouling shots.....	106	103
Fourth lecture (automatic fire and replacing magazines).....	211	187
Front sight, to aline.....	81	91
Functioning of—		
Buffer and rate reducing mechanism.....	21	29
Rifle.....	16	22
Mechanical means.....	18	22
Trigger mechanism.....	22	32
Fundamentals, marksmanship, moving ground targets.....	120	112
Fundamentals of training.....	48	53
Gas adjustment.....	31	38
Gloves.....	105	103
Grade of ammunition.....	42	49
Group firing.....	140	130
Gun sling.....	104	103
Handling of ammunition.....	44	51
Identification of ammunition.....	43	50
Immediate action.....	34	40

INDEX

	Paragraph	Page
Importance of—		
Landscape target firing.....	183	164
Range estimation.....	155	146
Rifle fire.....	153	146
Target designation.....	160	149
Inspection of rifles.....	203	177
Instruction:		
Method.....	53	56
Scope.....	154	145
Instruction firing.....	139	129
Instruction practice:		
On known-distance range.....	84	93
On 1,000-inch range.....	83	92
Instruction to pilots for towing missions.....	150	138
Instructors, assistant.....	201	176
Instruments, use.....	99	102
Interrupted score.....	108	103
Kneeling position.....	61	66
Landscape target firing.....	224	198
Scope and importance.....	183	164
Weapons to be used.....	185	164
Leaders, duties.....	52, 182	55, 163
Leads.....	128	119
Lectures.....	207	181
Sighting and aiming.....	208	181
Load—		
Magazine.....	26	36
Rifle.....	27	36
Lot number of ammunition.....	41	49
Magazine:		
Disassembly and assembly.....	12	13
To load.....	26	36
Magazines, exercises in replacing.....	67	71
Making shot groups (third sighting and aiming exercise).....	57	59
Marking.....	94	99
Marksmanship:		
Courses.....	75	82
Moving ground targets.....	119	112
Preliminary preparation, air targets.....	214	189
Training.....	132, 200	120, 176
Mechanical means of functioning.....	18	22
Methods of—		
Instruction.....	53	56
Range estimation.....	156	146
Target designation.....	162	149
Miniature range.....	147	135
Description.....	215	189
Firing.....	217	191
Practice.....	137	128
Misses.....	109	103
Model schedules.....	206	180
Moving personnel, method of aiming at.....	123	114
Moving targets and ranges.....	124	114



INDEX

	Paragraph	Page
Moving vehicles.....	122	113
Place in training.....	121	113
Nature of trajectory.....	167	157
Nomenclature.....	7	4
Object of range practice.....	73	81
Observation of fire.....	158	146
Operation of rifle.....	24	36
Oral target designation.....	165	150
Organization.....	5	3
Of firing line.....	92	98
Of work.....	205	178
On the range.....	77	88
Pads.....	105	103
Phases of training.....	49	53
Pointing.....	164	150
Position:		
Assault fire.....	62	66
Kneeling.....	61	66
Prone, with bipod rest.....	59	64
Second lecture.....	209	183
Sitting.....	60	65
Position exercises.....	58	60
First step.....	134	123
Position stoppage set-ups.....	199	175
Precautions:		
Range.....	125	117
Safety.....	32, 85, 138, 143, 193	39, 94, 128, 132, 171
Preliminary preparation, marksmanship, air targets..	214	189
Preparation of targets.....	186	165
Preparatory exercises.....	133, 216	121
Preparatory marksmanship training.....	50	54
Preservation of ammunition.....	44	51
Procedure in firing.....	144, 188	133, 168
With time limit.....	96	100
Without time limit.....	95	99
Prone position with bipod rest.....	59	64
Purpose of advice to instructors.....	197	175
Range:		
Estimation.....	220	195
Importance.....	155	146
Methods.....	156	146
Miniature.....	147	135
Officer.....	146	134
Practice.....	76	88
Object and scope.....	73	81
Sixth lecture.....	213	189
Precautions.....	125	117
Towed target.....	148	138
Ranges.....	118	107
Moving.....	124	114

INDEX

	Paragraph	Page
Rate of fire.....	178	181
Record practice:		
Course D, 1,000-inch range.....	116	104
Regulations governing.....	86	96
Replacing magazines, exercises in.....	67	71
Restrictions as to rifle.....	101	103
Rifle:		
To fire.....	29	37
To load.....	27	36
To unload.....	28	37
Rifles:		
Inspection.....	203	177
Zeroing-in.....	187	167
Remove and replace extractor without disassembling.....	11	12
Remove firing pin without disassembling.....	10	11
Rules for care of rifle.....	14	20
Safety precautions.....	32, 85, 138, 143, 193	39, 94, 128, 132, 171
Schedules, model.....	206	180
Scope of—		
Instruction.....	154	145
Landscape target firing.....	183	163
Range practice.....	73	81
Training, field target firing.....	192	170
Score book.....	71	74
Fifth lecture.....	212	187
Score interrupted.....	108	103
Score cards and scoring.....	93	98
Scoring.....	93, 145, 189	98, 134, 168 183
Second lecture (position).....	209	183
Second sighting and aiming exercise (alining silhouettes and sights).....	56	58
Second step (aiming and leading exercises).....	135	123
Sequence of exercises.....	88	96
Sequence of firing.....	74	82
Setting change lever.....	23, 30	33, 38
Shelter for frer.....	100	102
Shot groups.....	170	157
Shots:		
Cutting edge of silhouette or line.....	107	103
More than prescribed in time limit.....	115	104
To be included in score.....	110	104
Warming, fouling, and sighting.....	106	103
Sight changes (fifth lecture).....	212	187
Sight setting and aiming exercise.....	64	68
Sight setting exercises.....	63	68
Sighting and aiming (first lecture).....	208	181
Sighting and aiming exercises.....	55-57, 65	57-59, 69
Sighting bar (first sighting and aiming exercise).....	55	57
Sighting shots.....	106	103
Signals.....	151	140

INDEX

	Paragraph	Page
sitting position.....	60	65
situations for firing exercises.....	194	172
sixth lecture (range practice).....	213	189
simple parts.....	37	46
stoppages.....	35, 89	40, 96
Table.....	36	42
storage:		
Ammunition.....	45	51
Rifles.....	15	21
suggested exercises.....	196	173
table of stoppages.....	36	42
target:		
Description.....	184	164
Designation.....	129, 221	119, 197
Importance.....	160	149
Methods.....	162	149
Oral.....	165	150
Details.....	91	97
Firing on wrong.....	111	104
More shots than prescribed.....	115	104
Two shots on same.....	112	104
Withdrawing prematurely.....	113	104
Targets.....	117	107
Air.....	126	118
Men marking.....	90	97
Moving.....	124	114
Preparation.....	186	165
Technique of antiaircraft fire.....	127	118
Individual.....	130	119
Technique of fire.....	219	195
Telephone, use.....	97	102
Third lecture (trigger manipulation).....	210	185
Third sighting and aiming exercise (making shot coups).....	57	59
Third step (trigger manipulation exercises).....	136	124
Topographical terms.....	161	149
Top target—		
Firing.....	141, 218	131, 192
Range.....	148	138
Top targets.....	149	138
Training missions, instruction to pilots for.....	150	138
Tracer bullets.....	163	150
Use.....	157	146
Training:		
Conduct.....	198	175
in disassembly and assembly.....	4	3
in fundamentals.....	48	53
Marksmanship.....	132, 200	120, 176
Phases.....	49	53
scope of, field target firing.....	192	170
Trajectories, demonstration.....	174	159
Trajectory, nature.....	167	157
Trigger manipulation (third lecture).....	210	185
Trigger manipulation exercise.....	65	69
Third step.....	136	124

## INDEX

	Paragraph	Pa
Trigger mechanism, functioning.....	22	
Two shots on same target.....	112	1
Unfired cartridges.....	114	1
Unload rifle.....	28	1
Use of—		
Dummy cartridges.....	17, 25, 78	22, 36J
Instruments.....	99	2
Telephones.....	97	2
Tracer bullets.....	157	6
Warming shots.....	106	13
Wind and light, effect of (fifth lecture).....	212	37
Windage.....	68	73
Withdrawing target prematurely.....	113	34
Work, organization.....	205	78
Zero, explanation.....	70	74
Zero of rifle, to determine.....	82	91
Zeroing-in of rifles.....	187	167

